

EXHIBITOR MANUAL

- Application Forms -



APRIL 18 - 20, 2025

Venue: Makuhari Messe, Japan

LIST OF OFFICIAL CONTRACTORS

*These companies are optional. Other companies are also available at your convenience.

<Applications for Booth Construction / Preparation>

Shell Booth / Additional Furniture for Shell Booth / Consultation about Booth Decoration

Sakura International Inc.

Kamei No.2 Bldg., 5F, 17-13, Kiba, 2-Chome, Koto-Ku, Tokyo 135-0042, Japan
Contact: Ms. Inohara
TEL: +81-50-5804-1338
E-mail: starwars-s2025@sakurain.co.jp
Reception time : 10:00 - 12:00, 13:00 - 17:00 JST. (Mon - Fri)



DEADLINE :
Mar. 7 (Fri)

Electricity

IIDA Electrical Works Co., Ltd.

1-8-21 Shinkiba, Koto-ku, Tokyo 136-0082, Japan
Contact: Mr. Fujiwara / Mr. Tomo Nakamura
TEL: +81-3-3521-3522
E-mail: swcj2025@iidae.co.jp



DEADLINE :
Mar. 7 (Fri)

Rental Furniture

AZ Scene Corp.

10-8, Yochomachi, Shinjuku-ku, Tokyo 162-0055, Japan
Contact: Ms. Tamada
E-mail: overseas@azscene.co.jp
URL: <http://www.azscene.co.jp/eng>
Please contact us by E-mail.



DEADLINE :
Apr. 4 (Fri)

Communication Network Service

Kissei Comtec Co., Ltd.

Access <https://entry.mice-net.jp/ex/492/reg?lan=en>

Otsuka S&S Bldg., 3-32-1 Minami-Otsuka, Toshima-ku, Tokyo 170-0005, Japan
Contact: Mr. Kishi
TEL: +81-3-6709-2440
E-mail: intl-rxj@network.kcrent.jp



DEADLINE :
Mar. 14 (Fri)

PC Rental

Kissei Comtec Co., Ltd.

Otsuka S&S Bldg., 3-32-1 Minami-Otsuka, Toshima-ku, Tokyo 170-0005, Japan
Contact: Mr. Kishi
TEL: +81-3-6709-2440
E-mail: intl-rxj@network.kcrent.jp



DEADLINE :
Mar. 14 (Fri)

AV Equipment Rental

Edith Grove Co., Ltd.

5F Marusada Ariake Bldg., 2-14-4 Shinonome, Koto-ku, Tokyo 135-0062, Japan
Contact: Mr. Fredrik Persson
TEL: +81-3-5500-5362
E-mail: avrental@edithgrove.co.jp
URL: http://www.edithgrove.co.jp/index_english.html



DEADLINE :
Mar. 14 (Fri)



Floor Construction

Sakura International Inc.

Kamei No.2 Bldg., 5F, 17-13, Kiba, 2-Chome, Koto-Ku, Tokyo 135-0042, Japan
Contact: Ms. Inohara
TEL: +81-50-5804-1338
E-mail: starwars-s2025@sakurain.co.jp
Reception time : 10:00 - 12:00, 13:00 - 17:00 JST. (Mon - Fri)



DEADLINE :
Mar. 28 (Fri)

Rigging		
Sakura International Inc. Kamei No.2 Bldg., 5F, 17-13, Kiba, 2-Chome, Koto-Ku, Tokyo 135-0042, Japan Contact: Ms. Inohara TEL: +81-50-5804-1338 E-mail: starwars-s2025@sakurain.co.jp Reception time : 10:00 - 12:00, 13:00 - 17:00 JST. (Mon - Fri)		DEADLINE : Mar. 7 (Fri)
Water Supply		
Yamazaki Kogyo Co., Ltd. 3F 4-22-2, Koenjiminami, Sugunami-ku, Tokyo 166-0033, Japan Contact: Mr. Ishizuka TEL: +81-3-5305-5091 E-mail: ishizuka@yamazakikogyo.com		DEADLINE : Mar. 14 (Fri)
Compressed Air Supply		
Yamazaki Kogyo Co., Ltd. 3F 4-22-2, Koenjiminami, Sugunami-ku, Tokyo 166-0033, Japan Contact: Mr. Ishizuka TEL: +81-3-5305-5091 E-mail: ishizuka@yamazakikogyo.com		DEADLINE : Mar. 14 (Fri)
Booth Cleaning Service		
Chiba-ken Buil-Maintenance Coop. Contact: Mr. Sato / Mr. Yamaguchi TEL: +81-43-296-0090 E-mail: cb-event@cbm.or.jp		DEADLINE : Mar. 14 (Fri)
Handling Fire and Dangerous Materials for Exhibits and Demonstration		
Sakura International Inc. Kamei No.2 Bldg., 5F, 17-13, Kiba, 2-Chome, Koto-Ku, Tokyo 135-0042, Japan Contact: Ms. Inohara TEL: +81-50-5804-1338 E-mail: starwars-s2025@sakurain.co.jp Reception time : 10:00 - 12:00, 13:00 - 17:00 JST. (Mon - Fri)		DEADLINE : Mar. 7 (Fri)
Carrying-in / Demonstration of Hydrogen		
Sakura International Inc. Kamei No.2 Bldg., 5F, 17-13, Kiba, 2-Chome, Koto-Ku, Tokyo 135-0042, Japan Contact: Ms. Inohara TEL: +81-50-5804-1338 E-mail: starwars-s2025@sakurain.co.jp Reception time : 10:00 - 12:00, 13:00 - 17:00 JST. (Mon - Fri)		DEADLINE : Mar. 7 (Fri)
Ceiling Construction		
Sakura International Inc. Kamei No.2 Bldg., 5F, 17-13, Kiba, 2-Chome, Koto-Ku, Tokyo 135-0042, Japan Contact: Ms. Inohara TEL: +81-50-5804-1338 E-mail: starwars-s2025@sakurain.co.jp Reception time : 10:00 - 12:00, 13:00 - 17:00 JST. (Mon - Fri)		DEADLINE : Mar. 7 (Fri)

<Applications of Optional Services >

Interpreter / Translation Service

KIYO Corporation

5-2-18-1410 Mita, Minato-ku, Tokyo 108-0073, Japan

Contact: Ms. Aoki

TEL: +81-3-3453-1210

E-mail: sales@kiyocorp.com



DEADLINE :
Mar. 28 (Fri)

Additional Furniture for Booth Decoration

Contact

Sakura International Inc.

Contact: Ms. Inohara
 TEL: +81-50-5804-1338
 E-mail: starwars-s2025@sakurain.co.jp
 Reception time : 10:00 - 12:00, 13:00 - 17:00 JST. (Mon - Fri)

DEADLINE
Mar. 7 (Fri)

If you would like to order the additional furniture for booth decoration, please order from the following URL.

Application Form URL

https://miceform.jp/sakura_rop/

※ **This is not an order form. Please order the additional furniture via the above URL.**

Please go to the above URL for more details, pictures and color samples for the additional rental furniture items for booth decoration.

If you need items apart from the listed, please contact Sakura International Inc. by e-mail for further information.

(unit: mm)

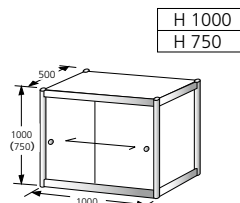
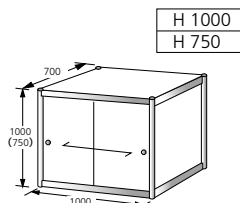
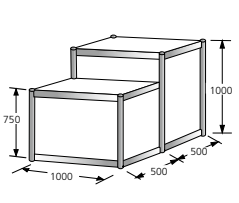
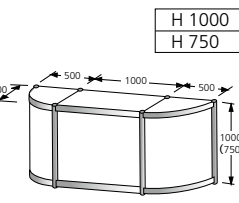
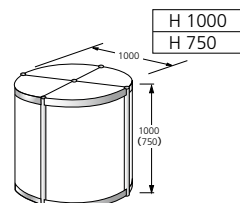
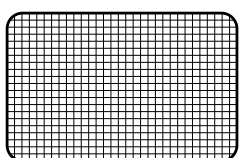
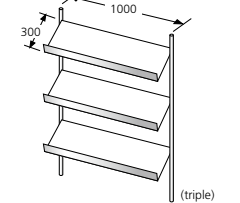
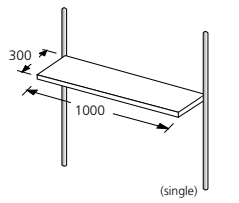
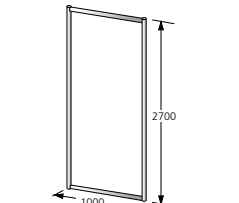
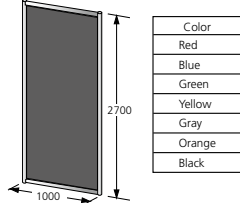
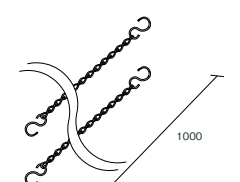
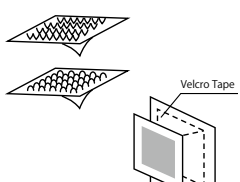
1 Display Table (with storage) 	2 Display Table (with storage) 	3 Display Table 	4 Display Table 	5 Round Display Table 								
6 Mesh Panel  <p>*For the color and size of Mesh Panel, please contact official contractor directly.</p>	7 Tilting Shelves  <p>(triple) *For the weight limit of the shelves, please contact the contractor.</p>	8 Shelf  <p>(single) *For the weight limit of the shelves, please contact the contractor.</p>	9 Wall Panel 	10 Coloring Sheet  <table border="1" data-bbox="1356 1321 1460 1478"> <thead> <tr> <th>Color</th> </tr> </thead> <tbody> <tr><td>Red</td></tr> <tr><td>Blue</td></tr> <tr><td>Green</td></tr> <tr><td>Yellow</td></tr> <tr><td>Gray</td></tr> <tr><td>Orange</td></tr> <tr><td>Black</td></tr> </tbody> </table> <p>*in addition to wall panel</p>	Color	Red	Blue	Green	Yellow	Gray	Orange	Black
Color												
Red												
Blue												
Green												
Yellow												
Gray												
Orange												
Black												
11 Chain & S-hook (2 pieces) 	12 Velcro (4 pieces) 											

Method of Payment

Invoice will be issued by the official contractor after the application. Please transfer to the designated account within one week from the issue date stated on the invoice.
 All bank charges must be paid by the exhibitor.
 The exhibitor will be charged for the bank commission fee. Please choose "OUR(Applicant)" relating to the transfer charge when making an international wire transfer.





● Electricity

- **In case of using the Shell Booth, it is not required to submit this form.**
- The Shell Booth includes basic electrical service. In case you need extra lighting, it is required to fill in **"Electrical Service"** to apply.
- If you require extra lighting, note that the additional primary wiring and branch circuit construction is required, regardless of the current wiring circuit construction and electrical consumption.
- Exhibitors are requested to refrain from bringing their own lighting equipment to avoid any electrical trouble on site. If there are any other items you require, contact the official contractor directly.
- Total price is calculated by adding the amount in (A), (C) and (D). Amount in (C) and (D) depend on the wattage of the lighting equipment you order.
- Amount indicated in (C) includes both construction and electricity consumption charge.
- Amount in (C) and (D) will be automatically charged according to the equipment you order. The period or the span in which the electricity is consumed is irrelevant. e.g. Either when the electricity was consumed from 8:00am (move-in time) or from 10:00am, the amount charged in (C) and (D) will be the same.

< SUPPLY HOURS >	The 2nd day of move-in	noon – 10:00pm
	The 1st day of the show	8:00am – the end of the show
	The 2nd day of the show	8:30am – the end of the show
	The last day of the show	8:30am – the end of the show

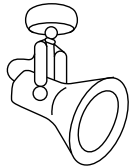
*Contact directly to the contractor for early / late electrical supply or any other inquiries.

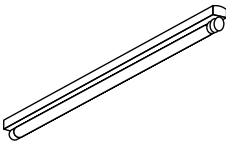
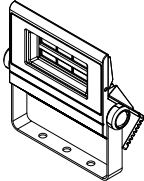
Rental Lighting Equipment Catalogue

1	LED Spotlight 15W (light bulb color / daylight color) JPY2,750	2	LED Spotlight with arm 15W (light bulb color / daylight color) JPY3,300
			
3	Fluorescent LED Lamp 21W (white lamp) JPY2,750	4	LED 60W (daylight color) JPY 16,500
			
5	Outlet 100V up to 1.5kW JPY 3,300		
			

*10% consumption tax included.

*If no color is specified for the spotlight, light bulb color will be set as default.

*Order these equipment by submitting the form **"Electrical Service"**.

Method of Payment

Official contractor will visit your booth to collect payment during the show period either in Japanese yen (cash) or the following credit cards (AMEX, VISA or Master).

*We will not take any cancellations after the construction is completed and will charge you the actual cost of the work.

*All paid fees are non-refundable and non-transferable.

*If additional work is required on site, please make the payment during the exhibition period.

MUST SUBMIT

Electrical Service

Send this Form to:

IIDA Electrical Works Co., Ltd.Contact: Mr. Fujiwara / Mr. Tomo Nakamura
TEL: +81-3-3521-3522
E-mail: swcj2025@iidae.co.jp**DEADLINE**
Mar. 7 (Fri)

Show Title:	Booth #:	-
Company Name:		
Contact (Mr./Ms.):	TEL:	
E-mail:		

Please tick Shell Booth : Fill 3) and 4) Custom-made Booth (Space Only) : Fill 1) and 4)**1) Your Electrical Contractor:**

Company Name:	TEL:
E-mail:	

2) Send invoice to:

Name:	TEL:
Company:	E-mail:

3) Primary Wiring Service for:

-Space Only Exhibitors

-Shell Booth Exhibitors who request a different power supply

100V single phase 50Hz		kW	JPY
200V single phase 50Hz		kW	JPY
200V three phase 50Hz		kW	JPY

4) Position

- Please specify the position of the main switch or submit a booth layout which indicates the position of the main switch.

Symbol of Main Switch

 100V 200V single phase 200V three phase

▲
Front of Booth

Connections at 100V (Secondary Wiring)

*10% consumption tax included

Lighting Equipment	Amount*	Watts
1. LED Spotlight 15W (light bulb color / daylight color)	JPY 2,750 × pcs.= JPY	pcs.= W
2. LED Spotlight with arm 15W (light bulb color / daylight color)	JPY 3,300 × pcs.= JPY	pcs.= W
3. Fluorescent LED Lamp 21W (white lamp)	JPY 2,750 × pcs.= JPY	pcs.= W
4. LED 60W (daylight color)	JPY 16,500 × pcs.= JPY	pcs.= W
5. Outlet 100V up to 1.5kW	JPY 3,300 × pcs.= JPY	(W) × pcs.= W
Total Amount (A) = JPY		Total Watts (B) = W

*Please specify the color of spotlight.

If not, light bulb color will be set as default.

*Please contact the contractor when you need outlets for 200V.

Primary Wiring

Branch Circuit Construction

Total Watts (B)	Amount (C)
under 1kW	JPY 13,200
1.01~2.0kW	JPY 26,400
2.01~3.0kW	JPY 39,600
3.01~4.0kW	JPY 52,800
Above 4.01kW	JPY 13,200/1.0kW

Total Watts (B)	Amount (D)
under 1.5kW	-
1.51~3.0kW	JPY 5,500
3.01~4.5kW	JPY 7,700
4.51~6.0kW	JPY 9,900
Above 6.01kW	JPY 2,200/1.5kW

Method of Payment

Official contractor will visit your booth to collect payment during the show period either in Japanese yen (cash) or the following credit cards (AMEX, VISA or Master).

*We will not take any cancellations after the construction is completed and will charge you the actual cost of the work.

*All paid fees are non-refundable and non-transferable.

*If additional work is required on site, please make the payment during the exhibition period.

Rental Furniture

Send this Form to:

AZ Scene Corp.
 Contact: Ms. Tamada
 E-mail: overseas@azscene.co.jp
 URL: <http://www.azscene.co.jp/eng>
 Please contact us by E-mail.

DEADLINE
Apr. 4 (Fri)

Show Title:	Booth #:	-
Company Name:		
Contact (Mr./Ms.):	TEL:	
E-mail:		

- Please access the following web page to see the catalogue for rental furniture.
https://lp.rxjapan.jp/b_azscene_10_2_en/ For ordering furniture, please submit this form.

NO	Item	Unit Price in JPY	Quantity	Total (JPY)
1	Meeting Table & Chair (white)	JPY 20,350		
2	Meeting Table & Chair (black)	JPY 20,350		
3	Meeting Table & Chair (white)	JPY 13,750		
4	Meeting Table & Chair (black)	JPY 13,750		
5	Meeting Table & Chair (round)	JPY 19,800		
6	High Counter Set	JPY 18,700		
7	Dining Table (W1200:white)	JPY 7,150		
8	Dining Table (W750:white)	JPY 7,150		
9	Dining Table (W1200:black)	JPY 7,150		
10	Dining Table (W750:black)	JPY 7,150		
11	Folding Table (W1800)	JPY 3,850		
12	Folding Table (W1500)	JPY 3,850		
13	Folding Table (W1200)	JPY 3,850		
14	Folding Table (W1800)	JPY 4,400		
15	Angular Table	JPY 2,200		
16	Round Table (Ø750)	JPY 4,400		
17	Round Table (Ø600)	JPY 4,400		
18	Stacking Chair	JPY 3,300		
19	Folding Chair	JPY 660		
20	Stand Chair (SH450)	JPY 3,850		
21	Stand Chair (SH600)	JPY 3,850		
22	Chair for computer use	JPY 4,400		
23	Cafe Chair (plywood)	JPY 6,050		
24	Cafe Chair (red)	JPY 6,050		
25	Unit Counter (W1200)	JPY 13,200		
26	Unit Counter (W1500)	JPY 14,300		
27	Unit Counter (W1800)	JPY 20,900		
28	Reception Counter (H750)	JPY 6,600		

NO	Item	Unit Price in JPY	Quantity	Total (JPY)
29	Reception Counter (H930)	JPY 7,700		
30	Stand Counter	JPY 11,000		
31	Gondola (H1650)	JPY 16,500		
32	Gondola (H1350)	JPY 16,500		
33	Partitions	JPY 12,650		
34	Mesh Panel	JPY 9,900		
35	Catalog stand	JPY 1,650		
36	Catalog stand	JPY 6,050		
37	Panel Stand	JPY 2,750		
38	Universal Stand	JPY 6,050		
39	Water Server	JPY 11,000		
40	Mineral Water (3 gallons)	JPY 2,750		
41	Refrigerator (100L)	JPY 16,500		
42	Refrigerator (70L)	JPY 14,300		
43	Coffee Manufacture	JPY 14,300		
44	Coffee Set (For 100 cups)	JPY 8,800		
45	Single Hanger	JPY 3,300		
46	Visiting Card Box	JPY 1,650		
47	Multipurpose Box (W600)	JPY 8,250		
48	Multipurpose Box (W900)	JPY 13,200		
49	Dust Box	JPY 715		
50	White Cloth	JPY 1,760		
51	Fire Extinguisher	JPY 4,400		
52	Indoor Plant	JPY 4,950		

(unit: mm)

*10% consumption tax included

Grand Total	JPY
--------------------	-----

NOTE:

- **AZ Scene Corp.** will contact you for confirmation within a week after your application. If not, please contact them directly, since your application may not be delivered properly.
- Product may differ slightly from the photo in the catalogue depending on the stock status.
- The prices in the above list cover the fee to lease, bring in and place the furniture in your booth.
- Furniture not listed above is also available. Contact **AZ Scene Corp.** directly.
- On-site orders can be accepted during the move-in and show period. In those cases, it is required to pay on site.
- The total amount must be paid on site in cash (Japanese yen) or credit cards (VISA, Master, AMEX, or JCB).

For further Information: <http://www.azscene.co.jp/eng/>

Method of Payment

Please tick the appropriate box.

- By bank transfer—Exhibitor will be charged for the bank commission fee of JPY 4,000 additionally.
- On-site payment—Credit card (JCB, AMEX, Diners Club, UC, VISA or MasterCard) or cash (only Japanese yen).
- Invoice needs to be issued by the official contractor.

Communication Network Service

Contact

Kissei Comtec Co., Ltd.
Contact: Mr. Kishi
TEL: +81-3-6709-2440
E-mail: intl-rxj@network.kcrent.jp

DEADLINE
Mar. 14 (Fri)

1. Order Method

- *You can apply available high speed internet services during period of the show.
Please read the exhibitor manual and place order to Kissei Comtec from the following QR.
- *There is no-free wi-fi in the venue.

Kissei Comtec is the official contractor of internet service for the exhibition.
If you have any questions regarding communication line services, please feel free to contact Kissei Comtec.

Please complete your order form by the deadline.

- *Create separate account ID for each exhibition booth.
- *Account ID is automatically assigned by the system.
- *You will receive a confirmation email after registration.
- *You can create multiple IDs with the same email address / password.
- *Kissei Comtec will issue an invoice after confirming your application. Installing process will be executed after payment is confirmed.

Kissei Comtec will start your installation work after confirming full amount of the payment.
Please complete your payment by the deadline.

2. Service Available Period

Your service is available from 14:00 on the 2nd day of move-in until the end of the show.

- *On-site installation work day : on the 2nd day of move-in



Application Form
URL

<https://entry.mice-net.jp/ex/492/reg?lan=en>

3. Service Options

- *10% consumption tax is not included all prices below.

MICE-NET Shared Connection 100Mbps(Dynamic IP) JPY 110,000

MICE-NET Shared Connection 100Mbps(Dynamic IP)+ Wi-Fi access point* JPY 165,000

- The service is that 1Gbps internet line shared by other booth.
- DHCP function is activated.
- If you need static IP address, extra fee is charged separately.
- Please prepare 2 outlets (100V) at the installation point.
- If you connect more than 8 PCs, Please prepare a hub by your side.

MICE-NET Provider(standard)(Dynamic IP address) JPY 165,000

MICE-NET Provider(standard)(Dynamic IP address)+ Wi-Fi access point* JPY 220,000

- MICE-NET Provider is a mice-only provider that does not use PPPoE connections.
- It is connected to the Internet from our data center by a VPN connection using FLET'S Hikari's IPv6 address.
- If mice-net provider fails, automatic backup by PPPoE is supported.
- Since a dedicated router and a dedicated HUB are installed, please prepare two power supplies at the line usage location.
- Proprietary optical line (family type) with MICE-NET Provider has a speed limit of 300 Mbps for both upload and download in order to maintain a stable speed.

*Notice Regarding Wi-fi Access Point

- There might be connectivity problem due to compatibility problem of hardware
(Problem that breaks out between the Wi-Fi devices on the side of the reception side and transmission side)
- Please prepare demonstration program or brochure by yourselves in case of performance deterioration of Wi-Fi device.
- Unique SSID and Password will be issued for each exhibitor.
- Wireless LAN access point shall be installed at where cable LAN is located within the booth.
- *The fee might be changed when the access point is necessary to install far from router.
- Wireless LAN standard shall be IEEE802.11 a/g.
- The use of device which is available for IEEE802.11/a is recommended.
- To prevent the interference trouble, please avoid using your own mobile router.

4. Payment (Paypal or Bank wire transfer)

After confirming your order, Kissei Comtec will issue formal estimate/order form and send you.
Please fill out order form then send back. As soon as Kissei Comtec confirms your order, they will issue your invoice.
*Kissei Comtec accepts Bank wire transfer (T/T) and PayPal. Please clarify your payment method.

● PC Rental

Please refer to the following list for types of rental PC.
 >>> Send application form to Kissei Comtec Co., Ltd.

Package Plan (PC rental with popular software installation and Windows Update)

No.	Presentation Plan	Price	OS	MS Office2021 is installed computers which includes Word, Excel and Power Point. (ACCESS is not included) If you require the following version of MS Office(2016, 2019), please contact us.
E1	DELL Latitude 3520 (English)	¥20,900	Windows10-Pro 64bit	
E2	DELL OptiPlex 3070SFF (English) ※1	¥23,650	Windows10-Pro 64bit	

No.	Security Plan	Price	OS	Antivirus software and the latest version of the Windows update software are installed for the security countermeasure.
E3	DELL Latitude 3520 (English)	¥18,700	Windows10-Pro 64bit	
E4	DELL OptiPlex 3070SFF (English) ※1	¥21,450	Windows10-Pro 64bit	

No.	All in One Plan	Price	OS	Microsoft Office 2021 Standard Edition, Antivirus software and the latest version of the Windows update software are installed. If you require the following version of MS Office(2016, 2019), please contact us.
E5	DELL Latitude 3520 (English)	¥26,400	Windows10-Pro 64bit	
E6	DELL OptiPlex 3070SFF (English) ※1	¥29,150	Windows10-Pro 64bit	

※1 Display is not included.

Laptop PC

No.	Items	Price	RAM	CPU	Graphic/VRAM/output-terminal	Drive	OS
E7	DELL Latitude 3520 (English)	¥13,200	16GB	Corei5-1135G7 2.4G	Intel Iris Xe Graphics HDMI	-	Win10-Pro 64bit
E8	Apple MacBook Pro MK1A3J/A M1 Max/32G/SSD1T/Liquid RetinaXDR	¥30,800	32GB	M1 MAX	Thunderbolt 4(USB-TypeC) x 3+HDMI	No DVD Drive	MAC OS 14

The theft of laptop PCs has been on increase at the exhibition.

We recommend you use security cables or keep PCs in a cabinet which can be locked every day after the exhibition.

Desktop PC

No.	Items	Price	RAM	CPU	Graphic/VRAM/output-terminal	Drive	OS
E9	DELL OptiPlex 3070SFF (English) ※2	¥14,300	8GB	Corei5-9500 3.0G	Intel HD VGA+HDMI+DisplayPort	DVDSuperMulti	Win10-Pro 64bit or Win11-Pro 64bit
E10	DELL OptiPlex 3050SFF (English) ※2	¥15,950	16GB	Corei7-7700 3.6G	Intel HD HDMI+VGA+DispayPort	DVDSuperMulti	Win10-Pro 64bit
E11	(For Desktop PC) ※3 24" TFT widescreen LCD display iiyama ProLite E2483HS-B1 others	¥12,100	FHD 24"(1920 x 1080), VGA+HDMI etc...				

※2 Display is not included. / ※3 it should be ordered with PC

iPad

No.	Items	Price	Reference
E12	Apple iPad 2021 Autumn MK2L3J/A Wi-Fi Silver (equivalent)	¥9,900	Wi-Fi model [IEEE802.11a/b/g/n/ac]
E13	Apple 12.9-inch iPad Pro MTEL2J/A Wi-Fi 64GB Space Gray	¥15,400	Wi-Fi model [IEEE802.11a/b/g/n/ac]

(10% consumption tax is included)

Delivery fee and tax are included to the prices. Fee of packing and setting-up are not included to the prices.

PC Monitor is only available with the set of PC. Orders of monitor(s) alone are not acceptable.

Depending of our warehouse stocks, the item would be changed as equivalent devices.

Please keep the accessories during the exhibition.

We also provide booth network wiring, configuration, installation, dismantling, etc.. Please contact Kissei Comtec Co.,Ltd. if you want.

After confirmation of your order, actual cost may be charged.

Please prepare 100 voltage outlet for charging or operating our rental devices.

Our internet device work 100V electricity only.

PC Rental

Send this Form to:

Kissei Comtec Co., Ltd.
 Contact: Mr. Kishi
 TEL: +81-3-6709-2440
 E-mail: intl-rxj@network.kcrent.jp

DEADLINE
Mar. 14 (Fri)

Show Title:	Booth #:	-
Company Name:		
Contact (Mr./Ms.):	TEL:	
E-mail:		

We apply for PC Rental service.

Kissei Comtec Co., Ltd. will contact you for confirmation within 3 days after application. If not, please contact them directly, since your email may not have been delivered properly.

Date, Time and Place for Delivery and Return:

Delivery	Date / Time	Place
	Choose one only: <input type="checkbox"/> The second day of move-in 10am-noon <input type="checkbox"/> Other time and date* () * Extra fee will be added if you choose "other time and date".	Choose one only: <input type="checkbox"/> On-site <input type="checkbox"/> Other ()
Return	Date / Time	Place
	Choose one only: <input type="checkbox"/> The last day of the show until 8pm <input type="checkbox"/> Other time and date* () * Extra fee will be added if you choose "other time and date".	Choose one only: <input type="checkbox"/> On-site <input type="checkbox"/> Other ()

Item No.	Item	Quantity	Amount

* The list shows only a part of our stock. Please contact Kissei Comtec Co., Ltd. if you need other items.
 * Please note that we might not be able to take your last-minute order.

Please pay the total amount by PayPal or bank transfer.

Make a payment by PayPal.

*If you have your PayPal account, please fill in your e-mail below.
 If not, please create your PayPal account and fill in your e-mail address.

E-mail: _____

*We will charge you via your PayPal account. You will receive the payment confirmation e-mail, read it carefully and make a payment before the due date.

Make a payment by bank transfer

*Please transfer a whole amount of remittance charge including fees for wire transfer and receiving commissions.

● AV Equipment Rental

● Please access the following web page to see the catalogue for AV equipment rental.

https://lp.rxjapan.jp/edithgrove_catalogue/

For ordering products, please submit the application form to Edith Grove Co., Ltd.

◆ Full Hi-Vision LCD				
Product name		Product Specifications		Rental Fee
1	90 inches LCD	SHARP PN-R903	Hi-stand included • HDMI/VGA input • Screen size: 1993 × 1121mm ◆ Please consult us if you wish to wall-mount the LCD.	396,000 JPY
2	70 inches LCD	SHARP PN-R703	HDMI/VGA input • Screen size: 1538.9 × 865.6mm ◆ Please consult us if you wish to install the LCD on a Foot-stand.	143,000 JPY
3	60 inches LCD	SHARP PN-R603	HDMI/VGA input • Screen size: 1329.1 × 747.6mm ◆ Please consult us if you wish to install the LCD on a Foot-stand.	132,000 JPY
4	55 inches LCD (Built-in USB Media Player)	Panasonic TH-55LF8J	Foot-stand included • HDMI/VGA/USB input • Screen size: 1209 × 680mm	88,000 JPY
5	48 inches LCD (Built-in USB Media Player)	Panasonic TH-48FE8J	Foot-stand included • HDMI/VGA/USB input • Screen size: 1054 × 592mm	77,000 JPY
6	42 inches LCD (Built-in USB Media Player)	Panasonic TH-42LF8J	Foot-stand included • HDMI/VGA/USB input • Screen size: 927 × 521mm	57,200 JPY
7	32 inches LCD (Built-in USB Media Player)	Panasonic TH-32EF1J	Foot-stand included • HDMI/VGA/USB input • Screen size: 698 × 392mm	33,000 JPY
8	27 inches LCD	I-O DATA EX-LD2702DB	Foot-stand included • HDMI/VGA input • Screen size: 597.9 × 336.3mm	16,500 JPY
9	21.5 inches LCD	I-O DATA LCD-MF223EBR	Foot-stand included • HDMI/VGA input • Screen size: 476.6 × 268.1mm	8,800 JPY
◆ 4K Compatible LCD				
Product name		Product Specifications		Rental Fee
10	4K Compatible 84 inches LCD	Panasonic TH-84LQ70J	Hi-stand included • HDMI/VGA input • Screen size: 1860 × 1047mm ◆ Please consult us if you wish to wall-mount the LCD.	440,000 JPY
11	4K Compatible 75 inches LCD	SONY KJ-75X8500E/BZ	Foot-stand included • HDMI/USB input • Screen size: 1653.7 × 932mm	176,000 JPY
12	4K Compatible 65 inches LCD	SONY KJ-65X8500E/BZ	Foot-stand included • HDMI/USB input • Screen size: 1433.5 × 808.7mm	148,500 JPY
13	4K Compatible 55 inches LCD	SONY KJ-55X8500E/BZ	Foot-stand included • HDMI/USB input • Screen size: 1213.6 × 684.4mm	99,000 JPY
◆ Display Installation Options				
Product name		Product Specifications		Rental Fee
14	Large Hi-stand (65-90 inches Displays)	Floor stand, moveable & height-adjustable for LCD Display • Installation included ◆ Only applicable to customers ordering displays.		19,800 JPY
15	Hi-stand (20-60 inches Displays)	Floor stand, moveable & height-adjustable for LCD Display • Installation included ◆ Only applicable to customers ordering displays.		16,500 JPY
16	Display wall-mount Installation (60-75 inches)	With wall-mount bracket. ◆ Only applicable to customers ordering displays.		33,000 JPY
17	Display wall-mount Installation (32-55 inches)	With wall-mount bracket. ◆ Only applicable to customers ordering displays.		22,000 JPY
18	Display wall-mount Installation (21.5-27 inches)	With wall-mount bracket. ◆ Only applicable to customers ordering displays.		11,000 JPY
◆ Playback Equipment				
Product name		Product Specifications		Rental Fee
19	Blu-ray Player	SONY UBP-X800	HDMI output • Playable media: BD-R/DVD-R/CD-R/USB	16,500 JPY
20	Region Free DVD Player	PLANTEC AV-2100CPRM	HDMI output • Playable media: DVD-R/CD-R	13,200 JPY
21	4K Compatible Media Player	BrightSign HD224	HDMI output • Playable media: microSD card (Included with the player) ◆ We urge you to send your video / image files to us in advance.	16,500 JPY
22	Media Player	BrightSign HD223	HDMI output • Playable media: microSD card (Included with the player) ◆ We urge you to send your video / image files to us in advance.	13,200 JPY
◆ Audio Equipment				
Product name		Product Specifications		Rental Fee
23	PA Pack ① (Speaker × 2, amp, wired mic × 1)	With clamp bracket • Mic input × 1 • Mic type: Headset or Handheld (can be selected) ◆ Please consult us if you wish to install the speakers on a stand.		33,000 JPY
24	PA Pack ② (Speaker × 2, amp)	With clamp bracket • Mini stereo/RCA input ◆ Please consult us if you wish to install the speakers on a stand.		26,400 JPY
25	Compact PA system (Powered speaker × 1, wired mic × 1)	Mic input × 2 • Line input × 2 • Mic type: Headset or Handheld (can be selected) Installation: Floor-standing/On the stand		16,500 JPY
26	PA Mixer	Mic input × 2~4 ◆ If you wish to use more than one microphone in the PA pack, please order this equipment as well.		4,400 JPY
27	Wired Handheld/Headset mic	Cable attached		4,400 JPY

*10% consumption tax included

Note:

1. To ensure your request, submit this form before the stated deadline. An alternative equipment will be recommended if your requested equipment is run out of stock.
2. The contractor will accept your order by confirmation of your payment. In the event of cancellation, refund will be made according to the Rental Agreement.
3. The contractor will be available for any maintenance required during the show period.
4. The above price includes lease, delivery, and adjustment/ maintenance fee. The price does not include any operator/ labor/ construction fee.

AV Equipment Rental

Send this Form to:	Edith Grove Co., Ltd. Contact: Mr. Fredrik Persson TEL: +81-3-5500-5362 E-mail: avrental@edithgrove.co.jp URL: http://www.edithgrove.co.jp/index_english.html	DEADLINE Mar. 14 (Fri)
Show Title:	Booth #:	-
Company Name:		
Contact (Mr./Ms.):	TEL:	
E-mail:		

Please choose from the product list and fill in the following form.

Item No.	Item	Quantity	Amount

*10% consumption tax included

Method of Payment	Upon receipt of application, Edith Grove Co., Ltd. will send an estimate. We will send you an invoice after confirming the reply of the order documents. All payment must be made via BANK TRANSFER and in JAPANESE YEN to the following account: Bank : SUMITOMO MITSUI BANKING CORPORATION, SHIBUYA-Branch A/C Name: Edith Grove Co., Ltd. Branch No.: 654 A/C No.: 7874902
--------------------------	---

*Include remittance charge in your payment.

● Floor Construction Regulations

1. Installation of Hole-in Anchors

- 1) Exhibitors planning to install hole-in anchors should submit a detailed drawing of the booth construction, including the number and location of anchors. If you wish to change the number of anchor bolts (including not to install any) after your application, please submit the application again by noon on the day before the show. No change is accepted after the exhibition. Anchor bolts installed without application may be charged. The hole-in anchor should not be deeper than 80mm and wider than 16mm in diameter, as shown in the images below.
- 2) Actions listed below are strictly prohibited. In case of violation, the exhibitor will be charged for restoration after the show.
 - a) Installing hole-in anchors onto pit covers
 - b) Using materials other than hole-in anchors (concrete screws, nails, etc.)
 - c) Using strong adhesive tape that damages the original state of the floor
 - d) Coloring the floor
 - e) Installing anchors within 200mm from the edge of the pit
 - f) Using inside screw type anchor bolt
 - g) Using anchor bolts other than "Strike Anchors"*Other kinds of anchor bolts including "Drop-in Anchors", "Cut Anchors" and "Sleeve Anchors" are NOT acceptable.

2. Restorations to the Original State

If the hole-in anchors protrude from the floor surface, instead of pulling them out, be sure to cut them off in order to restore the floor to its flat state. It is prohibited to drive hole-in anchors into the concrete with a hammer nor cutting them off with gas.

If such are found, including damaging the floor, the exhibitor will be charged for restoration after the show.

■ Hole-in Anchor Installation

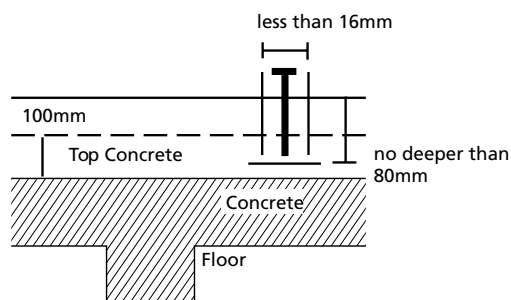

■ Restoration

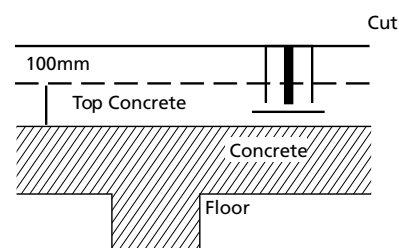

3. Requests for PIT Plan

Please refer to the page of "Inquiries Regarding PIT Plan" in the EXHIBITOR MANUAL – Regulations – and contact RX Japan for PIT Plan.

Floor Construction

Send this Form to:	Sakura International Inc. Contact: Ms. Inohara TEL: +81-50-5804-1338 E-mail: starwars-s2025@sakurain.co.jp Reception time : 10:00 - 12:00, 13:00 - 17:00 JST. (Mon - Fri)	DEADLINE Mar. 28 (Fri)
Show Title:	Booth #:	-
Company Name:		
Contact (Mr./Ms.):	TEL:	
E-mail:		

- Exhibitors who wish to lay a temporary concrete foundation or install anchor bolts for the purpose of installing machines for demonstrations, are required to apply to Show Management for pre-approval. Forward a copy of the booth layout along with this application.
- If anchor bolts are embedded without submitting this form, the fee may be billed to the exhibitor.
- If you lay temporary concrete foundation or install anchor bolts without approval, be aware that these will be charged after the show period.
- In case you change the number of the hole-in anchors, please re-submit this form by noon on the day before the show. Please note that re-submitting the form after the exhibition is not accepted.
- The size of anchor bolt must be within 80mm in length and 16mm in diameter.

Booth Contractor:

Booth Contractor					
Person in Charge	Dept.		Name		TEL
Construction	anchor bolt <Diameter>		mm, <Length>		mm, pieces
Construction Date					

Check the box if you have read and agree the following list defines the actions that are prohibited.

Any violations of the following actions may be charged for restoration.

- a) Installing hole-in anchors onto pit covers
- b) Using materials other than hole-in anchors (concrete screws, nails, etc.)
- c) Using strong adhesive tape that damages the original state of the floor
- d) Coloring the floor
- e) Installing anchors within 200mm from the edge of the pit
- f) Using inside screw type anchor bolt
- g) Using anchor bolts other than "Strike Anchors"

I have read and agree to the above actions of violations.

Rigging

Send this Form to:	Sakura International Inc. Contact: Ms. Inohara TEL: +81-50-5804-1338 E-mail: starwars-s2025@sakurain.co.jp Reception time : 10:00 - 12:00, 13:00 - 17:00 JST. (Mon - Fri)	DEADLINE Mar. 7 (Fri)
	Show Title:	
Company Name:		
Contact (Mr./Ms.):		TEL:
E-mail:		

Please note below.

1. The organizer doesn't hang any products except for the media kit.
2. Once the hangings for your booth are approved from sales team and operation team, you need to submit application to the official constructor, Sakura Int'l, to get approval from the venue.
3. The working hours for rigging will be specified by Show Management.

Booth Contractor:

Booth Contractor			
Person in Charge	Dept.		Name
	E-mail		TEL

Details of Rigging:

Material of Rigging Object	<input type="text"/> e.g. Tarpaulin
Size of Object	<input type="text"/> mm × <input type="text"/> mm e.g. 1000mm x 1000mm
Total Weight of Object	<input type="text"/> kg e.g. 15.0kg
Desired Height from the floor to top of the object	<input type="text"/> mm allowable height range 4000-6000mm e.g. 5500mm
Primary Rigging Points (Minimum 2 points required)	<input type="text"/> points e.g. 2 points
Planned Start Time (Rigging work should be started first)	<input type="checkbox"/> Apr. 14 <input type="text"/> e.g. Apr. 14 15:30 <input type="checkbox"/> Apr. 15 <input type="text"/> *Choose Apr. 14 or Apr. 15. *Show Management may assign a time slot to you depending on your booth location.

Sakura International will contact you for more details after receiving your application. If you do not receive any contact from Sakura International in one week after the application, please contact them to avoid any oversight.

Water Supply

Send this Form to:	Yamazaki Kogyo Co., Ltd. Contact: Mr. Ishizuka TEL: +81-3-5305-5091 E-mail: ishizuka@yamazakikogyo.com	DEADLINE Mar. 14 (Fri)
	Show Title:	
Company Name:		
Contact (Mr./Ms.):		TEL:
E-mail:		

Specification *All prices include 10% consumption tax.

< WATER SUPPLY >

Standard Inlet: 1/2" or 3/4"

Standard Outlet: 3/4" to 2"

Hydraulic Pressure: under 0.2MPa – 0.3MPa

Cost: JPY 93,500/unit for construction

*Including maintenance fee but excluding connecting charge to your equipment

JPY 803/cubic meter for use of water

< SUPPLY HOURS >

The 2nd day of move-in noon – 10:00pm

The 1st day of the show 8:00am – the end of the show

The 2nd day of the show 8:30am – the end of the show

The last day of the show 8:30am – the end of the show

*Contact the official contractor directly for early / late water supply or any other inquiries.

1. Application

We require:		
Water Volume	_____	liter/min.
Hydraulic Pressure	_____	MPa
Water Inlet	_____	inches
Water Outlet	_____	inches
<input type="checkbox"/> Connection to our booth		JPY 93,500
<input type="checkbox"/> Connection to our equipment (additional charge incurred)		

2. Position

Specify the position of water/drain or submit a booth layout which indicates the position of water/drain.

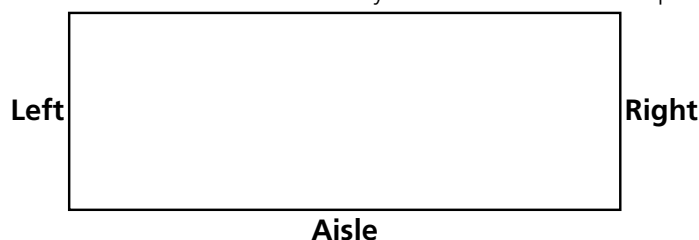

Method of Payment	Invoice will be issued by the official contractor after the application. Please transfer to the following bank account(JPY ONLY) 10 days before the first day of exhibition. The exhibitor will be charged for the bank transfer fee.
	Bank: MUFG Bank, LTD Branch No.: 206 KOENJI BRANCH A/C Name: YAMAZAKI KOGYO Co., Ltd. A/C No.: 155-1345042 Swift Code: BOTKJPJT

Compressed Air Supply

Send this
Form to:

Yamazaki Kogyo Co., Ltd.
Contact: Mr. Ishizuka
TEL: +81-3-5305-5091
E-mail: ishizuka@yamazakikogyo.com

DEADLINE
Mar. 14 (Fri)

Show Title:	Booth #:
Company Name:	-
Contact (Mr./Ms.):	TEL:
E-mail:	

Specification *All prices include 10% consumption tax.

<AIR PLUMBING>

Standard Air Lines: 1/2" or 3/4"
Standard Air Supply: 0.5MPa – 0.75MPa, 300 liter/min.
Exceeding in 300 liter: JPY 11,000/100 liter
Cost: JPY 93,500/unit
 *Including maintenance fee but excluding connecting charge to your equipment

<SUPPLY HOURS>

The 2nd day of move-in noon – 10:00pm
The 1st day of the show 8:00am – the end of the show
The 2nd day of the show 8:30am – the end of the show
The last day of the show 8:30am – the end of the show

*Contact the official contractor directly for early / late compressed air supply or any other inquiries.

1. Application

We require:
 Pressure _____ MPa Volume _____ liter/min.
 Supply Only JPY 93,500
 Supply and connection to our equipment (additional charge incurred)

2. Position

Specify the position of air supply or submit a booth layout which indicates the position of air supply.



**Method of
Payment**

Invoice will be issued by the official contractor after the application. Please transfer to the following bank account(JPY ONLY) 10 days before the first day of exhibition. The exhibitor will be charged for the bank transfer fee.

Bank: MUFG Bank, LTD
 Branch No.: 206 KOENJI BRANCH
 A/C Name: YAMAZAKI KOGYO Co., Ltd.
 A/C No.: 155-1345042
 Swift Code: BOTKJPJT

Booth Cleaning Service

Send this Form to:	Chiba-ken Buil-Maintenance Coop. Contact: Mr. Sato / Mr. Yamaguchi TEL: +81-43-296-0090 E-mail: cb-event@cbm.or.jp	DEADLINE Mar. 14 (Fri)
Show Title:	Booth #:	-
Company Name:		
Contact (Mr./Ms.):	TEL:	
E-mail:		

Daily booth cleaning service is not included in the Shell Booth.

Service charge: **JPY 2,673* per 1 regular booth (3m x 3m)** *10% consumption tax included.
 covering 3 days (second day of move-in and first and second day of the show)

The cleaning service covers:

- a) Booth construction period (**The second day of move-in**):
 Sweeping, collecting and disposal of all trash consisting of straw, packing materials, carton boxes, paper, etc.

ALL CRATES AND PLYWOOD SUCH AS CABLES, WIRES, UNUSED CARPETS OR BOARDS MUST BE REMOVED BY YOUR OWN CONTRACTOR.

- b) Exhibition period (**The first and second day of the show**): each evening
- Vacuuming of carpet
 - Emptying of waste baskets (Place them in the aisles each evening. Cleaners will not remove trash inside your booth).

We apply for daily booth cleaning service.

Booth No.

JPY 2,673 × _____ booth(s) = JPY _____

Note:

- This cleaning service includes basic booth cleaning only. Exhibitors are responsible for the removal of any large garbage. Thus, any such wastes removed on behalf of the exhibitor will be charged to the exhibitor.
- It is the exhibitors' responsibility to ensure that all crates, boxes or plywoods are removed or stored properly. There is no storage in the exhibition halls.
- This cleaning service is available by **advance order only**. **On-site orders including move-in period will not be accepted.**
- This service does not include cleaning polishing of exhibits, furniture and equipment.

Method of Payment	Payment should be made directly to the official contractor . They will visit your booth to collect full payment during the show period. Only Japanese yen (cash) will be accepted. Credit cards are not accepted.
--------------------------	---

● Handling Fire and Dangerous Materials For Exhibits and Demonstration

1. Application to Fire Department

- According to the Fire Service Act, using fire or bringing dangerous materials in the exhibition halls is prohibited. Special permission from the Fire Department is required if you wish to carry out these actions. **Please submit the application form before the stated deadline.**
- Inspections from the Fire Department will be conducted during the move-in and exhibition period. Please be aware that the equipment will have to be removed if there is any violation to fire regulations, including handling dangerous goods without application or incomplete construction. Submission after the deadline may not be approved by the Fire Department. Show Management will handle all applications to the Fire Department.
- **Prepare booth layout indicating the position of equipment, a catalogue of the equipment, a schedule of demonstration, a calculation report of consumption and quantity of heat released and a material safety data sheet (SDS/MSDS) for application.**
- If you do not receive any replies within a week after your application, please contact official contractor to avoid any oversight.

2. Guidelines for Application of the Use of Fire

(I) Definition of Naked Flame

- a. Materials which generate flames and sparks with the usage of gaseous, liquid and solid fuels, and equipment which its heating part is exposed.
- b. Equipment using electricity which its heating part is burning visibly (hotplate, hair dryer and oven is not included), and the heating part exposed may ignite when flammable materials meet the heating part (surface temperature is 400°C or above).

(II) Regarding the Use of Fire

- a. The use of fire is prohibited except when it is necessary for display for demonstration. In order to use fire at the exhibition hall, permission from the Fire Department is required. Regulations regarding energy consumption or installation have to be followed. Candles or alcohol lamps as decorations are prohibited.
- b. If you wish to use gas, please consult in advance.
- c. When it is permitted by the Fire Department as a special case, firefighting equipment must be installed in the booth. (Exhibitor is responsible for the expenses for the installation)
- d. The Fire Department will lift the restriction if there is no problem with the above guidance after the inspection. The Inspector will require for the explanation of the use of fire or gas during the inspection. The person-in-charge of the booth construction is required to station at the booth during the inspection. If the person-in-charge is not at the booth when the inspection is carried, the restriction will not be lifted.

(III) Installation and Safety Measures

- a. Flammable materials should not be placed 5m around the equipment using fire. If it is not possible to leave 5m space from the equipment using fire, separate the equipment with fireproof materials from the surroundings. In this case, the equipment should not be attached to the partition wall.
e.g. separating by pasting 2 pieces of asbestos slates with thickness of more than 15mm
- b. Equipment using fire must install measures to prevent any falls during earthquakes or outbreak of fire.
- c. Equipment using gas as fuel must have a gas-leak alarm.
- d. The person-in-charge who is responsible to operate the equipment should station at the booth at all time.
- e. Measures should be taken to ensure the user can extinguish the fire easily.
- f. Store liquified gas in cartridges.
- g. The flames generated should not be longer than 20cm.
- h. Take measures to protect the visitors from any potential dangers of fire.
- i. Refrain from any usage apart from the original purpose.
- j. Check before and after the usage.
- k. Install an ABC extinguisher (Type 10 or above) at the booth.

3. Guidelines for Application of Handling Dangerous Goods

(I) Definition of Dangerous Materials

- a. Dangerous goods include flammable liquid, oxidizing solid and liquid (e.g. gasoline and diesel fuel) according to the Fire Service Act.
- b. Designated flammable goods include flammable liquid and flammable solid under the Fire Prevention Ordinance of Chiba City.
- c. Flammable gas (e.g. propane, acetylene gas, ammonia gas, hydrogen) prescribed in the General High Pressure Security Regulations.
*You can only bring in liquefied gas which is excluded from the General High Pressure Security Regulations.
- d. Gunpowder, pyrotechnics and toy fireworks prescribed in the Explosives Control Law.

(II) Installation and Safety Measures

- a. Assign a person in charge for supervision and inspection after use.
- b. Place ABC dry chemical fire extinguisher (10lb or above) at the booth.
- c. Install device to emit the flammable steam outside the exhibition hall.
- d. Use fireproof materials to prevent the dispersion of flammable liquid.
- e. Avoid placing the dangerous goods together if they may get ignited easily.
- f. Refrain from refilling the liquid dangerous goods during the period of exhibition.
- g. Store the dangerous good in a closed container and keep it separated from the other goods.
- h. Follow the instructions of the Fire Department regarding the agreement of storing dangerous goods.

(III) Dangerous Material prescribed in Appended Table 1, Fire Service Act

Class I Petroleum (Flash point lower than 21°C)	Gasoline, Benzine, Thinner
Class II Petroleum (Flash point 21°C-69°C)	Kerosene, Gas Oil, Detergent Oil, Turpentine Oil
Class III Petroleum (Flash point 70°C-199°C)	Heavy Fuel Oil, Machine Oil, Lubricant Oil, etc.
Class IV Petroleum (Flash point 200°C or above)	Gear Oil, Cylinder Oil, Turbine Oil, Hydraulic Oil, etc.
Alcohol	Contains 60% alcohol or above
Oil extracted from animals and plants	Coconut Oil, Rapeseed Oil, Castor Oil, etc.
Inflammable solids	Lacquer Putty

*Please use water-soluble cutting oil.

(IV) Other Dangerous Goods

- a. Designated flammable material according to the Fire Prevention Ordinance (Flammable solid or liquid): paraffin, candles, raw materials of plastic.
- b. Flammable gas prescribed in the General High Pressure Security Regulations: propane, acetylene gas, hydrogen.
*You can only bring in liquefied gas which is excluded from the General High Pressure Security Regulations.
- c. Explosives prescribed in the Explosives Control Law: gunpowder, explosives, pyrotechnics.

(V) Items not considered as Dangerous Goods

The following items are not considered as dangerous goods if the amount is restricted to the minimum as needed.

- a. Exhibit : It is stored in a closed container which is for display only. Application of amount of the display is needed.
- b. Fuel or lubricant used in the tank of the vehicle for display only.
- c. Lubricant used in the motors and hydraulic machines for display.
- d. Oil for cooking and greasing the frying pan. (Deep-frying is not included.)

*The Fire Service Act and the Fire Prevention Ordinance is also applied when the total amount exceeds the prescribed amount even if it is exempted from dangerous goods.

< SUPPLEMENTARY >

★ Regarding Handling Flammable Gas

According to the Principle of Disaster from Makuhari Messe, only liquefied gas which is excluded from the General High Pressure Security Regulations is allowed to use for demonstration. Propane, acetylene gas and hydrogen (cylinder) is prohibited for any usage or demonstration.

* Only 5kg or below of liquefied gas excluded from the General High Pressure Security Regulations are allowed to be brought in.

* Liquid propane gas (LPG) stored in Cartridge up to 5kg is allowed to bring in and use.

Handling Fire and Dangerous Materials for Exhibits and Demonstration

Send this Form to:	Sakura International Inc. Contact: Ms. Inohara TEL: +81-50-5804-1338 E-mail: starwars-s2025@sakurain.co.jp Reception time : 10:00 - 12:00, 13:00 - 17:00 JST. (Mon - Fri)	DEADLINE Mar. 7 (Fri)
Show Title:		Booth #: -
Company Name:		
Contact (Mr./Ms.):		TEL:
E-mail:		

If you do not receive any contact from the official contractor in one week after the application, please contact them to avoid any oversight.

■ The Use of Naked Flame

Equipment Name <small>(Dangerous Material's Name)</small>	Heat Source	Maximum Consumption (kw/hour)	Number of Equipment	Purpose

When using naked flame, please submit three copies of the picture or the catalogue of the dangerous equipment, and a floor plan indicating the location of naked flame and fire extinguishers.

■ Display of Dangerous Materials (Please refer to the following classification and fill in below.)

First Petroleum: acetone, gasoline **Second Petroleum:** kerosene, gas oil **Third Petroleum:** heavy oil, creosote oil **Fourth Petroleum:** gear oil, cylinder oil

Classification	Name	Quantity	Type of Container	Demonstration	Purpose
First Petroleum					
Second Petroleum					
Third Petroleum					
Fourth Petroleum					
Alcohol					
Other					
Other					
Other					

- *Please indicate the weight and the number of each solid fuel such as candles.
- *Please submit three copies of an installation floor plan, a catalogue, and a material safety data sheet (SDS/MSDS).
- *Please take fixed measures when you bring a cylinder of flammable gas and high pressure gas.

■ The Use of High-pressure Gas

Name/Type	Quantity	Number	Purpose

*Please indicate the quantity and the number of flammable gas materials such as lighters.

■ Cautions

- 1) A person in charge of the booth takes full responsibility for the management of construction, display, and removal.
- 2) An ABC fire extinguisher (type 10 or more) must be installed in a booth.
- 3) A guard must observe the booth all the time in case of unexpected accidents such as fire.

● Carrying-in/Demonstration of Hydrogen

Carrying in hydrogen and demonstration of products using hydrogen are prohibited in the exhibition halls. However, it is permitted if it fulfills the requirements of the fire regulations.

The deadline of application is earlier than in the past years according to the instructions of the Fire Department.

Please submit the application form to the official contractor before the stated deadline. Any applications made after the deadline will not be guaranteed.

*If you do not receive any replies within a week after your application, please contact official contractor to avoid any oversight.

1. Application Procedures

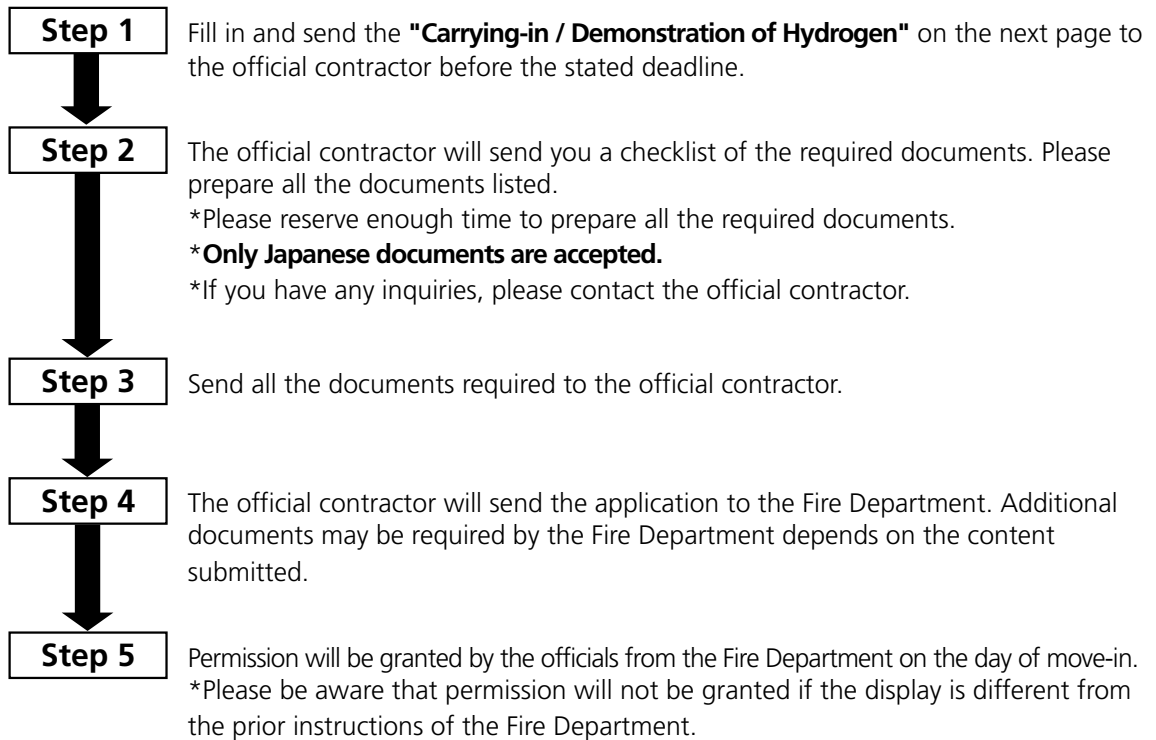

2. Caution

- (1) Application is required for carrying in hydrogen storage alloy according to the instructions of the Fire Department.
- (2) Only the minimum amount of hydrogen for daily usage is permitted for carrying in to the exhibition hall. Replenishment of hydrogen during the show period is not permitted.
- (3) Place fire extinguisher at the booth.
- (4) The person in charge for safety should be at the booth all the time, including the move-in period.
- (5) Only products approved in Japan are allowed to use in demonstrations.
- (6) Inspections will be conducted strictly based on the Fire Prevention Ordinance.
- (7) Demonstrations may not be permitted if there is any incomplete document for application.

Carrying-in/Demonstration of Hydrogen

Send this Form to:	Sakura International Inc. Contact: Ms. Inohara TEL: +81-50-5804-1338 E-mail: starwars-s2025@sakurain.co.jp Reception time : 10:00 - 12:00, 13:00 - 17:00 JST. (Mon - Fri)	DEADLINE Mar. 7 (Fri)
	Show Title:	
Company Name:		
Contact (Mr./Ms.):		TEL:
E-mail:		

If you do not receive any contact from the official contractor in one week after the application, please contact them to avoid any oversight.

APPLICATION FORM

I would like to apply as follows.

Company			
Address			
Person in Charge		TEL	
Person in Charge of Safety		Emergency Number (mobile phone)	
Carrying-in Amount of Hydrogen	_____ kg × _____ tank		
Type of Container	Storage alloy / Mixed gas cylinder / Others ()		
Dangerous Materials other than Hydrogen			
Exhibiting Experience at Makuhari Messe	(year)	(month)	Show Name

● Ceiling Structure

1. Exceptions for Ceiling Structure

Anything other than below are considered as ceiling structure, regardless of its size.

- Louvers and nets (both should be open more than 55%)

2. Ceiling Structure

It is prohibited to hang a ceiling unless louver boards are used to preserve water permeability.

If the exhibits do not function properly as how they are supposed to without light interception or sound insulation, please use flameproof black-out curtains or similar material for ceiling.

No matter what dimension it is, when constructing a ceiling, please inform the ceiling and shielding construction layout to the official contractor.

Please adhere to the following contents when designing the booth;

- a) Double ceiling is not allowed at all times.
- b) Materials used for decoration must be all flameproof materials. Please attach flameproof seal on these materials.
- c) You will be informed specific guidance for construction after consulting with Fire Department. (You may be asked to prepare size 10 or bigger fire distinguishers, smoke detectors, etc.)
- d) After the consultation mentioned in c), there is inspection by the Fire Department. As long as no problem is found in the inspection, they will give permission. Please be prepared to have a person in charge at the inspection to explain the structure of the construction. If there is no one to be responsible, the permission is not to be obtained.
- e) If constructing floor is higher than 30cm, consultations are needed. Please contact Show Management before the construction.

3. Forms and Consultation

*A consultation with the Fire Department is required if the ceiling structure is not an exception stated above (1. Exceptions for Ceiling Construction).

Please submit application and below documents.

- flat/elevation plan of your booth (with location of shielding curtains/fire extinguishers clearly indicated)
- detailed booth plan with description of ceiling construction (area of the ceiling, fire-proofed material of the ceiling indicated)

*A consultation with the Fire Department might take time. Forms after the deadline are not accepted in principle.

Ceiling Construction

Send this Form to:	Sakura International Inc. Contact: Ms. Inohara TEL: +81-50-5804-1338 E-mail: starwars-s2025@sakurain.co.jp Reception time : 10:00 - 12:00, 13:00 - 17:00 JST. (Mon - Fri)	DEADLINE Mar. 7 (Fri)
Show Title:	Booth #:	-
Company Name:		
Contact (Mr./Ms.):	TEL:	
E-mail:		

To: Mihama Fire Department

Date _____

Exhibitor Name _____ signature

Name of Person in Charge _____

Contact Number _____

Application for Ceiling Structure at the Makuhari Messe

1) Exhibition Name: _____

2) Opening Period: _____

3) Venue: Makuhari Messe

4) Booth #: _____

5) Type of Structure: Ceiling Structure

6) Purpose of Setting Up Ceiling Structure:

7) The Area and Height of Ceiling Structure: _____ sqm (area), _____ m (height)

8) Materials for Ceiling Structure:

9) Measures for Setting Up Ceiling Structure:

- * An ABC fire extinguisher (type 10 or more) must be installed in a booth.
- * _____ (Person's name) will be stationed at the booth for observation.
- * Black curtains and lighting equipment will be placed more than 10 cm away from each other.
- * Anti-flammable labels will be attached at a place that can be seen easily from the surrounding area.
- * Other measures, if necessary.

***Please submit flat / elevation plan of your booth and detailed booth plan with description of ceiling construction.**

Interpreter

Send this Form to:	KIYO Corporation Contact: Ms. Aoki TEL: +81-3-3453-1210 E-mail: sales@kiyocorp.com	DEADLINE Mar. 28 (Fri)
	Show Title:	
Company Name:		
Contact (Mr./Ms.):		TEL:
E-mail:		

Please forward this application directly to *KIYO Corporation*.

Upon receipt of application, *KIYO Corporation* will send a confirmation and invoice.

Type	Daily Rate*	Description	Dates and Number of Person and Language	
Senior Sales Assistant (ENG/CHN/KOR)	JPY 47,000	Representing a tier beyond Sales Assistant, these individuals excel in negotiations, demonstrating a talent for closing deals and fostering enduring relationships with clients. Additionally, accompanying interpreters are also available in the vicinity of the venue during the exhibition period. This service includes a 1-hour online meeting prior to exhibition.	person(s)	From : - To : (days) Language: _____
Sales Assistant (ENG/CHN/KOR)	JPY 40,000	Focusing on securing target leads and presenting the strengths and appeal of the products to visitors in detail. As part of the exhibitor's team, these individuals strive to achieve set goals. This service includes a 30-minute online meeting prior to exhibition.	person(s)	From : - To : (days) Language: _____
General Interpreter (ENG/CHN/KOR)	JPY 33,000	Interpreters at this level are having thoroughly prepared with relevant materials beforehand. They possess experience in interpretation and are wellversed in exhibition procedures.	person(s)	From : - To : (days) Language: _____
Other Language French/Italian/German/ Russian etc	JPY 50,000~	Same services as General Interpreter	person(s)	From : - To : (days) Language: _____
Booth receptionist (ENG/CHN/KOR)	JPY 24,000	Individuals at this level serve as booth receptionist, assisting with only basic communication tasks such as distributing pamphlets. *They do not possess negotiation skills.	person(s)	From : - To : (days) Language: _____
Booth receptionist (Japanese only)	JPY 23,000	Assist exhibitors in communication with visitors as a booth receptionist, performing only basic communication tasks such as distributing pamphlets. *NO language assistance is provided.	person(s)	From : - To : (days) Language: _____

*Daily rate includes interpreters' lunch and transportation, 10% consumption tax is not included.

*Cancellation fees apply as follows:

14 business days before opening day: 50% of the total fee

7 business days or less before opening day: 100% of the total fee

[OPTIONAL SERVICE] Available with additional charge.

Please contact us if you have any requirements for the following services.

- **Sales Assistance Service : <Pre-exhibition service and Follow-up service>**
- Airport escort
- Assist in the preparation of the booth prior to the exhibition
- MC and seminar/press conference interpretation

[NOTE]

- 1) Services outside the venue will be provided in accordance with the specified conditions.
- 2) Working hours will correspond to the opening hours of the exhibition, with the exception of a one-hour lunch break.
Interpreters will arrive 30 minutes prior to the start of the first day of the exhibition.
- 3) On-site interpretation requests are generally not accepted, however if available, it can be arranged for a 50% surcharge.

Payment Method	All payment must be made via BANK TRANSFER and in JAPANESE YEN to the following account:
	Bank: MUFG Bank, LTD (0005) HIROO BRANCH (047)
	A/C Name: KIYO CORPORATION
	A/C No.: Ordinary Account: 047-1238881 Swift Code: BOTKJPJT
	Bank Address: 4-1-1, Hiroo, Shibuya-ku, Tokyo 106-0047 Japan

Translation

Send this
Form to:

KIYO Corporation
Contact: Ms. Aoki
TEL: +81-3-3453-1210
E-mail: sales@kiyocorp.com

DEADLINE
Mar. 28 (Fri)

Show Title:

Booth #:

-

Company Name:

Contact (Mr./Ms.):

TEL:

E-mail:

RATE:

From English to Japanese	JPY 5,000 per 160 words
From Italian German French Chinese Korean to Japanese	JPY 6,000 per 160 words

(*10% consumption tax is not included)

*Please send this form together with the materials you would like to be translated. Upon receipt of your order, an invoice relevant to the number of words and type of language will be forwarded for your immediate attention.

*Please note that an additional 50% fee will be charged when the time given for translation is less than one week.

*The above rates covering up to 160 words are the minimum charges for an order.

Please send the translated materials to:

Company:

Attn.: Mr. Ms.

Address:

E-mail:

Country:

TEL:

<country code>-<area code>-<direct no.>

**Method of
Payment**

Upon receipt of application, **KIYO Corporation** will send a confirmation together with bank information.