

EXHIBITOR MANUAL

- Regulations -



APRIL 18 - 20, 2025

Venue: Makuhari Messe, Japan

Table of Content

Content	Page
I. Basic Information of Exhibition Venue.....	3
● Makuhari Messe Facility Guide	3
● Access	3
● Parking	3
● Show Schedule	4
● Rules and On-site Regulations	5
● Sound Level and Prohibited Activities	6
II. Move-in/out	7
● Cautions for Move-in/out of Exhibits	7
● Visitation of Minors in the Pavilion	8
● Procedures about Entry to the Hall.....	8
III. Regulations and Applications for Booth Construction	9
● Regulations and Applications for Booth Construction	9
● Regulations for Booth Construction	10
● Inquiries Regarding PIT Plan.....	12
● Fire Regulations.....	13
● Notes and Precautions	14
● Removal of Trash	14
● No Smoking	14
● Floor Construction Regulations.....	15
● Electricity.....	16
● Water Supply	16
● Compressed Air Supply	16
● Handling Fire and Dangerous Materials for Exhibits and Demonstration.....	17
● Carrying-in/Demonstration of Hydrogen	20
● Ceiling Structure	21
● Protection of Industrial Property Rights	22
● About the Use of Personal Information	22
● Details of Shell Booth (3m x 3m).....	23

I. Basic Information of Exhibition Venue

● Makuhari Messe Facility Guide

Please check from the URL below:

◆ <https://www.m-messe.co.jp/en/facility/>

● Access

Please check from the URL below:

◆ <https://www.m-messe.co.jp/en/access/>

● Parking

Please check from the URL below:

◆ <https://www.m-messe.co.jp/en/access/#car>

● Show Schedule				
Schedule		Vehicle Entry	Exhibitor Badge	
Move-in				
16 April (Wed)	8:00am–8:00pm Move-in for Space Only Stand	8:00am–8:00pm	To be announced	
17 April (Thu)	8:00am–12:00noon Move-in for Space Only Stand 12:00noon–8:00pm Move-in for Shell Booth Exhibitors	8:00am–12:00noon No vehicles are allowed to enter the halls after 12:00noon.		
<p>·Exhibitors (including your own booth contractors) who wish to work overtime after 8:00pm are required to submit an application form at the onsite Show Management Office. (Free)</p> <p>·Vehicle pass is required for every vehicle enters the halls.</p> <p>·Details of exhibitor badge and vehicle pass will be announced later.</p>				
Exhibition				
18 April (Fri)	7:00am–8:45am Doors Open for Exhibitors (preparation for the show)	No vehicles are allowed to enter the halls.	7:00am–7:00pm	
	8:45am–9:00am Show Open to Priority Ticket Holders			
	9:00am–6:00pm Show Open to General Ticket Holders			
	6:00pm–7:00pm Stand Restocking			
19 April (Sat)	7:30am–8:45am Doors Open for Exhibitors Stand Restocking (preparation for the show)		No vehicles are allowed to enter the halls.	7:30am–7:00pm
	8:45am–9:00am Show Open to Priority Ticket Holders			
	9:00am–6:00pm Show Open to General Ticket Holders			
	6:00pm–7:00pm Stand Restocking			
20 April (Sun)	7:30am–8:45am Doors Open for Exhibitors Stand Restocking (preparation for the show)	7:30am–4:00pm		
	8:45am–9:00am Show Open to Priority Ticket Holders			
	9:00am–4:00pm Show Open to General Ticket Holders			
Move-out/ Dismantling				
20 April (Sun)	4:30pm–6:30pm Exhibits Move-out (hand carry only)	6:30pm–11:00pm	To be announced	
	6:30pm–11:00pm Dismantling and Move-out			
21 April (Mon)	8:00am–2:00pm Dismantling and Move-out	8:00am–2:00pm		
·Vehicle pass is required for every vehicle enters the halls.				

Note:

- **The height of vehicles entering the hall must be less than 3.8m.**
- No vehicles are allowed to enter the halls after **1:00pm on 17 April (Thu)**. Be sure to finish moving in all the large machinery/luggage before **1:00pm**.
- Removal of exhibits and dismantling of stands are strictly prohibited before **4:00pm on the last day of the show**.
- Be careful for any possible accidents while moving out. Booth dismantling takes place simultaneously for all exhibitors.

● Rules and On-site Regulations

1) No Smoking

Makuhari Messe is a non-smoking venue. Smoking in the exhibition halls, including inside your own booths, is prohibited for the entire show period as well as move-in/out days. It is only permitted in designated smoking areas outside the building. Make sure that your contractors as well as your own staff do not smoke. They may be asked to leave the halls if they are found smoking inside the building.

2) No Sales Activities Outside Your Booth

Sales activities (such as handing out pamphlets and questionnaire, etc.) are permitted only inside your booth. Placing them outside your booth (hall entrance/exit) without permission of Show Management is prohibited.

3) Preventing Accidents caused by Demonstrations

Be sure to take precautions against any damage, loss, fire disaster, etc. that may be caused by demonstrations. Make sure that beam, hot air, dust, gas, odor, vibration, etc. from your booth do not harm other exhibitors.

4) Responsibility for Exhibits and Insurance

Exhibitors are responsible for securing their own booth, display and products. Neither Show Management, Makuhari Messe, the contractors, nor any of their officers/agents/employees are responsible for loss, damage or theft of property.

Exhibitors are strongly advised to insure their exhibits against loss and take every precaution to protect exhibit products and personal belongings. Do not leave expensive items at the booth each night after the show.

5) Height limit of vehicles entering the hall

The height of vehicles entering the hall must be less than 3.8m.

6) Exhibiting Heavy Products

In case of bringing heavy products (Hall 1-9: 5t/m²), additional consultations about placement of them are needed. Please contact Show Management in advance.

7) Securing Aisles

If you hold presentations or demonstrations in your booth, you must keep enough room inside your booth for your audiences and also arrange staff to keep the aisles clear for other visitors.

8) Demonstration using Flying Objects

Any demonstration using flying objects is prohibited.

9) Sampling Food and Drink

In case of selling or providing food and drink, contact your sales representative and operation team.

● Sound Level and Prohibited Activities

(1) Sound coming from your booth (including presentations, demonstrations, narration, etc.) must be lower than 80 decibels.

If you hold demonstrations or presentations inside your booth, be sure to keep the volume lower than 80 decibels measured at 1.5 meters away from your booth. Show Management will warn you to turn down the volume if you do not comply with the regulation.

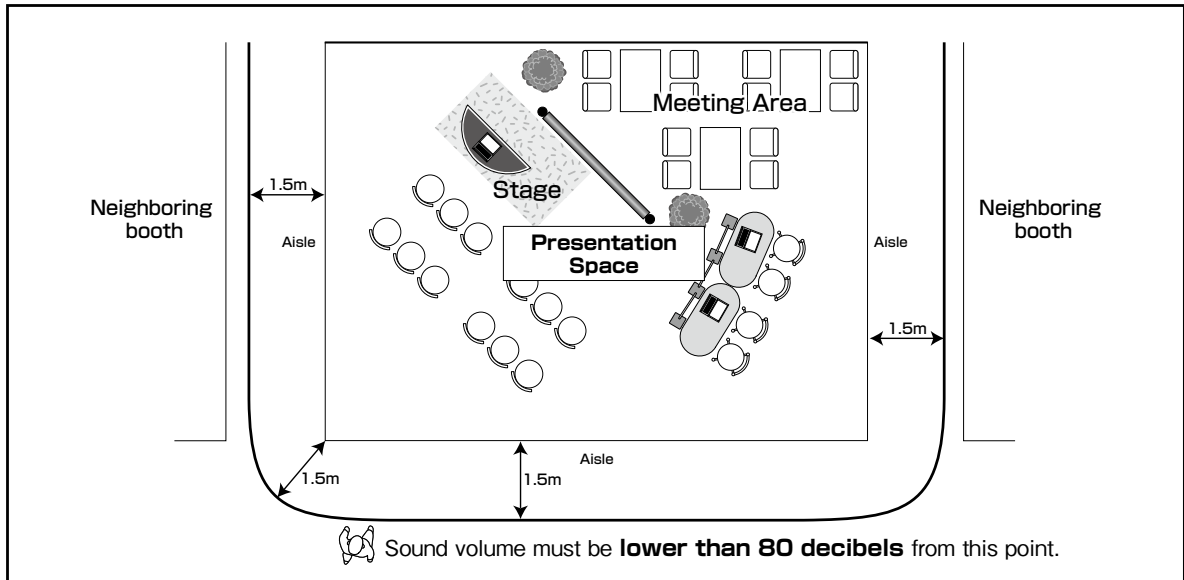

(2) The following sales activities are prohibited OUTSIDE your booth.

- Booth attendees (including booth bunnies) handing out giveaways, questionnaires, etc.
- High-pressure sales by booth attendees (including sales representative).

(3) Leading visitors and advertising in a loud voice is prohibited.

(4) Blowing bugles, ringing bells, playing instruments and using other noisemakers (megaphone, etc.) are strictly prohibited.

*If you go against the regulations above, you may get banned from participating in the show.

II. Move-in/out

● Cautions for Move-in/out of Exhibits

- 1) There is no storage space for empty cases, crates and boxes, and Show Management will not provide any. If you require empty crates/boxes for your move-out, please store them properly. Contact your own contractor in advance for storage service (charged).
- 2) It is exhibitors' responsibility to remove or store all crates, boxes and plywood properly. Any crates, boxes and plywood left after the show will be disposed and its cost will be charged to the exhibitor. Note that disposal of large volume wastes does cost additional fees.
- 3) **Illegal parking, especially double/triple parking near the gates, is not allowed and is subject to heavy penalty. This applies to all exhibitors as well as contractors. Kindly advise your contractors and staff.**
- 4) If exhibits are delivered to the booth directly by vehicles, please confirm the width of the aisles of the exhibition hall in advance.
- 5) **The height of vehicles entering the hall must be less than 3.8m.**
- 6) Details of Badges for delivery companies will be announced later.
- 7) Evacuate all exhibits and booth materials during the period of Dismantle and Move-out. Show Management will dispose or remove all the exhibits and booth materials found in the exhibition halls after the period of Dismantle and Move-out ends. Show Management takes no responsibility for any damages or loss arising from the disposal or removal. Please check the Show Schedule for the duration of Dismantling and Move-out. The cost incurred during the disposal or removal may be charged to the exhibitor.
- 8) Specify the time of delivery when sending the parcels and make sure there is a recipient at the booth during the selected timeslot. If you send parcels of exhibits or publication materials directly to the booth, please indicate your booth number, company name and name of the recipient on the shipping label clearly. Check the booth number from your sales representative. Show Management will not receive nor keep parcels on your behalf. Show Management takes no responsibility for any loss or damage of your parcels when there is no receipt in your booth.

Box Marking

Make sure that all boxes are marked as below.

Company Name: _____ Booth No.: _____ Hall: _____ Attn.: Mr./Ms. _____ Show Title: _____ Makuhari Messe <u>2-1 Nakase, Mihama-ku, Chiba-shi Chiba 261-8550, Japan</u> Case No.1/X (X=total number of cartons)
--

9) Vehicle Pass

- "Vehicle Pass" is required for all vehicles to enter the exhibition halls during the move-in/out period. Details of Vehicle pass will be announced later.

- No vehicles are permitted to enter the exhibition halls **during the show period**. Exhibits/catalogues/ brochures, etc. must be hand-carried to the exhibition halls from the hall entrances. In this case, parking lots (charged) are available for unloading.

● Visitation of Minors in the Pavilion

It is expressly forbidden the entry of minors under 18 (eighteen) years of age, even if accompanied by their guardians, during the periods of Assembly(move-in) and Disassembly(move-out) of the EVENT.

● Procedures about Entry to the Hall

Exhibitor Badges

- Exhibitor Badge is required to enter the exhibition halls during the 3 days of the show.
It is required to register all staff who will attend the booth.

Exchange your exhibitor badges on site. Details will be announced later.

- Badges are not required **during move-in and move-out period.**

Wristband may be required during move-in period depends on your booth location.

III. Regulations and Applications for Booth Construction

● Regulations and Applications for Booth Construction

For better preparation, please check with the following list to avoid missing any deadlines.

<Must Submit>

For Shell Booth

[Click here for Details of Shell Booth](#)

- Electrical Service Form *If extra lighting is needed

For Booth Decoration with your own contractor

- Electrical Service Form
- Approval from Disney License Representative for booth design *All licensees with space-only booths

<Application (Optional)>

- Additional Furniture for Booth Decoration
- Rental Furniture
- Communication Network Service
- PC Rental
- AV Equipment Rental
- Floor Construction
- Rigging (hanging from ceiling)
- Water Supply
- Compressed Air Supply
- Booth Cleaning Service
- Handling Fire and Dangerous Materials for Exhibits and Demonstration
- Carrying-in/Demonstration of Hydrogen
- Ceiling Construction

Application Forms are available in the EXHIBITOR MANUAL -Application Forms-

● Regulations for Booth Construction

***All licenses with space only booths must submit their booth designs to their Disney License Representative for approval.**

1) All stands must be furnished with at least decorations below.

- Back & Side Walls (2.7m-3.6m height)
- Company Name Board
- *No decoration is included in raw space charge.
- *If the booth is exposed to aisles on all four sides, back and side walls are not needed. Yet, back wall(s) is(are) needed for the side which is not facing the aisle.

2) The height limit of the stand (including decoration) is 3.6m (without setback). The walls must be built between the adjacent stands and they cannot be lower than 2.7m.

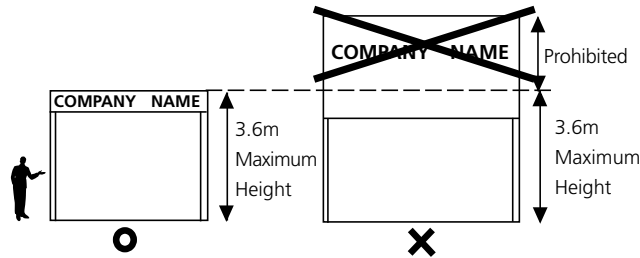

a) All booth decoration and its associated equipment should be set below the height of 3.6m, including signboards, arches, floating objects (e.g. balloons) and plants for display.

b) If your exhibits are higher than 3.6m, contact Show Management in advance.

3) Stand construction is confined to the contracted stand space only. Any signboards, arches, flags, furniture or exhibits should not protrude into the aisles nor extend beyond the rented space. It is also prohibited to spray any mist outside your booth. The carpet covering your own booth should be limited to your own contracted space.

This does not apply to:

- booth number plates and other materials distributed by Show Management
- lightings to illuminate Company Name Board

4) If your stand is higher than adjacent stands, you must paint or cover the rear surface of the portion with white wall paper or white panels. When the wall height is different from the adjacent stands, it is prohibited to place any letters including company name facing those stands within 1 meter from the adjacent wall. For peninsula booths, the rear surface of the wall facing adjacent booth(s) is required to be covered with white wallpaper or white panels.

5) When constructing a wall within 1 meter from the aisle, the wall must be kept open for 1/3 of the length or more on each side.

This does not apply to:

- the wall facing the wall/pillar of the venue.
- the side walls of the booth which is located at the outermost of the venue.
- the booth is exposed to aisles on all four sides.

Example of a corner booth with 2 open sides

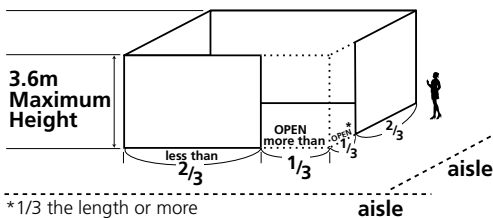

Example of a booth in between booths

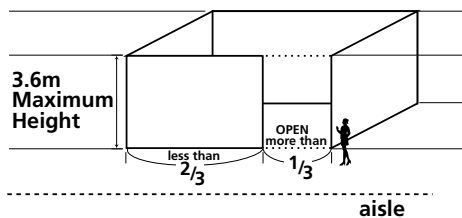

When a panel higher than 1m is constructed between the ground and 2.7m height as shown below, it will be considered as a wall. *This does not apply to the part higher than 2.7m.

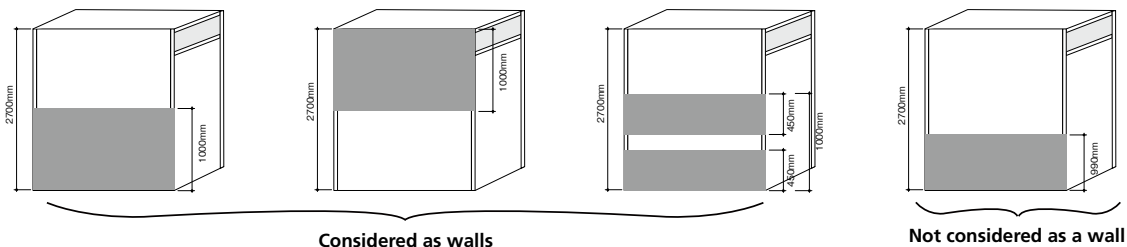

III. Regulations and Applications for Booth Construction

- 6) Regarding rigging, please note below.
 - The organizer doesn't hang any products except for the media kit.
 - Your booth including the hanging decoration cannot exceed the height limit of 3.6m. The highest ceiling height of the halls is 30 meters.
 - Once the hangings for your booth are approved from sales team and operation team, you need to submit application to the official constructor, Sakura Int'l, to get approval from the venue.
 - The working hours for rigging will be specified by Show Management.
- 7) If you plan to hold demonstrations or presentations in your booth, leave enough room for your audience to keep their attention inside your booth space.
- 8) **Two-story construction for the stand is available at an additional cost.** Please contact your sales representative for more details.
- 9) Carpet in the stand may only be laid using weak double-sided adhesive tape. Using glues or adhesive bonds is prohibited.
- 10) Any decorations or exhibits must not obstruct firefighting equipment and facilities, such as fire extinguishers, fire hydrants, sprinklers, emergency bells, emergency exit signs, etc. Also, exhibits should not be left unattended in these areas. Contact Show Management for the location of firefighting equipment.
- 11) Ceiling construction and shielding curtains are prohibited in principle. Any exhibitors planning to have a ceiling construction or shielding curtains are required to submit application for ceiling construction.
- 12) Take measures to strengthen the booth structure in order to prevent any collapse or damages from strong wind due to the opening/closing of shutter and iron door. Especially for the booths locates right beside the foundation wall of exhibition hall (there is no other booths between the foundation wall and your booth).

Show Management will not be responsible for any damages of exhibits, accidents, injuries, trouble occurred due to the collapse of booth.

Contact Show Management for inquiries regarding the distance between your booth and shutter/iron door.

● Inquiries Regarding PIT Plan

1. Information that you can get in the PIT Plan

- Types of PIT (electricity, air or water) in your booth: You can decide where the equipment should be placed
- Distance from different PIT to/inside your booth: No anchor installation and floor construction is allowed within 200mm from the edge of the pit.

2. Request for PIT Plan

Contact: Person in Charge of PIT Plan, Show Management
 E-mail: swcj2025-pitmap.jp@rxglobal.com

This e-mail is for requesting PIT Plan ONLY.

If you have other requests or inquiries, such as checking the details of booth decoration, please contact Show Management directly.

3. Required Information

Please send the following information by e-mail.

- Booth: Booth Number, Exhibitor Name
- Contact: Company Name, Person in charge, E-mail Address

4. Notice

- PIT plan is available from 2 months before the exhibition. PIT plan is not ready for earlier inquiries.
- PIT plan will be sent within 3 working days.

5. Example of a PIT Plan

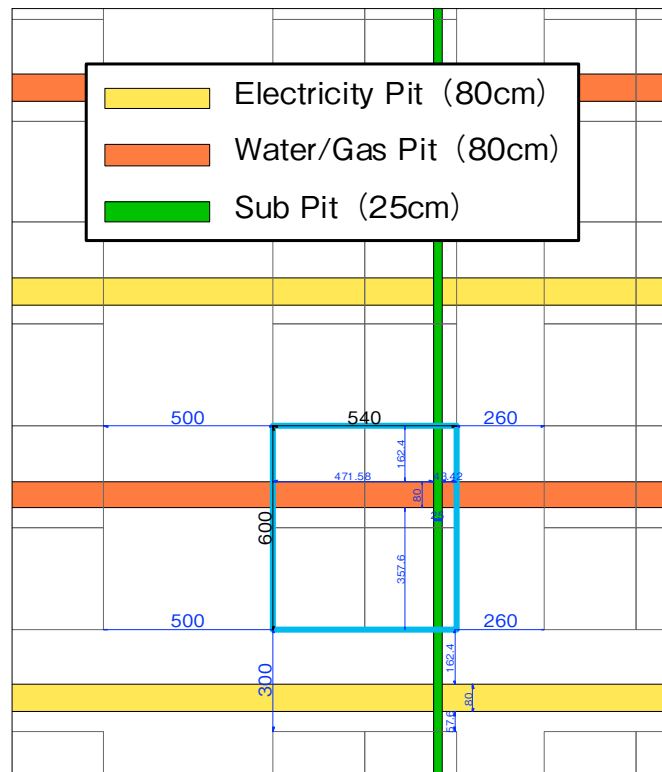

● Fire Regulations

Local fire officials will carry out inspections of the exhibition halls during move-in and show period. Fire officials have **final authority** on all safety and fire regulations, and have a right to order exhibitors **to remove any materials or to dismantle a booth if they do not comply with the fire regulations**. Makuhari Messe is designated as a fireproof building, according to the eighth article of the fire laws. Therefore, please use anti-flammable decorations at the exhibition.

1) Panels for booth construction

Panels or any wall materials i.e. plywood board and printed plywood board, used for booth construction or for other furniture including decorations and reception counters, are **required to be soaked in an anti-flammable liquid in advance and should be labeled as anti-flammable accordingly**. Application of anti-flammable spray onsite will not be accepted as a proper procedure.

2) The use of fireproof materials

(I) Materials which have to be anti-flammable

- Accordion curtains or screens made of cloth, used for partition
- Hanging materials made of cloth, used for decoration on the wall
- Blinds made of cloth
- Curtains (all kinds of cloth curtains, drapes and blackout curtains, etc.)
- Screens for projectors
- Carpets, artificial lawns, mats
- Sheets

(II) Fireproof materials

- Nonflammable materials, prescribed in Article 2-9 of the Building Standard Act
- Quasi-nonflammable materials, prescribed in Article 1-5 of the Order for Enforcement of the Building Standard Act
- Plywood which is considered as a flame-retardant material, prescribed in Article 1-6 of the Order for Enforcement of the Building Standard Act

3) Anti-flammable label for each fireproof material

- The label must be attached at the most visible place.
- The label must be properly attached on the materials so that it does not come off easily.

4) Materials without fireproof capacity

Refrain from using plastic materials such as artificial flowers, urethane, acetate fiber, polyester, coolite or isolite, acrylic, nylon, etc. It is hard to apply fireproof finish to these materials.

5) Use of materials with domestic anti-flammable labels

- Foreign goods under the flame retardancy requirement, described as in 1) and 2) above, must have domestic anti-flammable labels in order to meet the domestic regulations.
- Foreign goods without anti-flammable labels must have the authorization from the Japanese qualifying activity.

6) Any actions that cause fire

Gas welding and any actions that cause fire are strictly prohibited unless pre-approved by Show Management. Please note that you must contact Show Management in advance, and must have a fire extinguisher in your booth when you use fire.

● Notes and Precautions

- 1) Due to the actual location of electrical pit in the venue, the electric cable may not be possible to be arranged to an unnoticeable location inside the booth. Contact the official contractor to confirm the location of electric mainline in advance before designing your booth.
- 2) Vehicles may be restricted temporarily from entering the exhibition halls for purpose of safety and adjustments. Please also note that vehicles may be required to wait outside.
- 3) Exhibitors must not damage or alter in any way the exhibition facilities, including electrical lines, lights, water facilities, stand decorations or exhibits of other exhibitors. In case of damage, exhibitors must return any damaged objects to their original state regardless of any reasons.
- 4) It is not allowed to paint directly on the pillars, or stick posters with adhesives or adhesive tapes. Building panels around the pillar or covering it with cloth without using adhesives are permitted. There may be fire extinguishers by the pillar. In such cases, please be sure they are not covered or hid away. For details, please contact Show Management in advance.
- 5) In case of using a drum-type cord reel, be sure to pull the wound cord completely off from the reel.
- 6) Booth construction and demolishing should be done inside your contracted space. No material is allowed to be left in the aisle or other space.
- 7) Redecorating your booth during the show period is prohibited.
- 8) There is no storage space in the exhibition halls. Prepare stock space in your own booth if necessary.

● Removal of Trash

Exhibitors are responsible for the removal of all trash. Any items including catalogues, books, etc. remaining in stands will be regarded as trash, and exhibitors will be charged for its removal. Contact the official contractor (refer to the list in the EXHIBITOR MANUAL –Application Forms–), if you request for cleaning service.

● No Smoking

Smoking in the exhibition halls, including inside your own booth, is strictly prohibited.

*About the Use of Personal Information

We are taking the utmost care with personal information. Please visit the following URL to see our company policy. <https://privacy.rxglobal.com/>

● Floor Construction Regulations

1. Installation of Hole-in Anchors

- 1) Exhibitors planning to install hole-in anchors should submit a detailed drawing of the booth construction, including the number and location of anchors. If you wish to change the number of anchor bolts (including not to install any) after your application, please submit the application again by noon on the day before the show. No change is accepted after the exhibition. Anchor bolts installed without application may be charged. The hole-in anchor should not be deeper than 80mm and wider than 16mm in diameter, as shown in the images below.
- 2) Actions listed below are strictly prohibited. In case of violation, the exhibitor will be charged for restoration after the show.
 - a) Installing hole-in anchors onto pit covers
 - b) Using materials other than hole-in anchors (concrete screws, nails, etc.)
 - c) Using strong adhesive tape that damages the original state of the floor
 - d) Coloring the floor
 - e) Installing anchors within 200mm from the edge of the pit
 - f) Using inside screw type anchor bolt
 - g) Using anchor bolts other than "Strike Anchors"

*Other kinds of anchor bolts including "Drop-in Anchors", "Cut Anchors" and "Sleeve Anchors" are NOT acceptable.

2. Restorations to the Original State

If the hole-in anchors protrude from the floor surface, instead of pulling them out, be sure to cut them off in order to restore the floor to its flat state. It is prohibited to drive hole-in anchors into the concrete with a hammer nor cutting them off with gas.

If such are found, including damaging the floor, the exhibitor will be charged for restoration after the show.

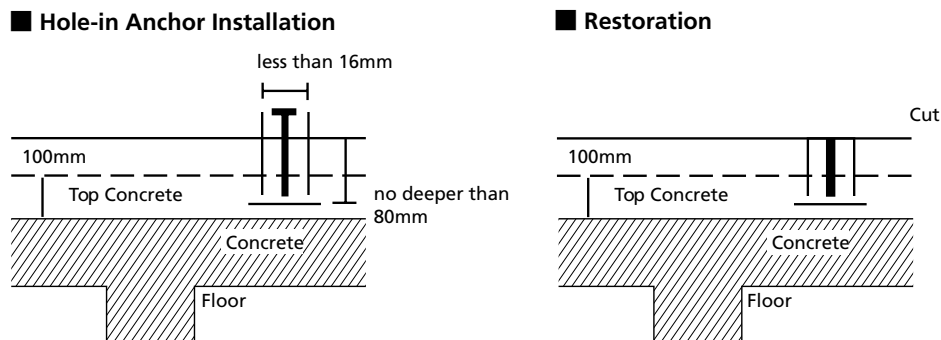

3. Requests for PIT Plan

Please refer to the page of "Inquiries Regarding PIT Plan" and contact RX Japan for PIT Plan.

● Electricity

Please submit the application for electrical service in your booth.
In case of using the Shell Booth, it is not required to submit this form.
If you need extra lighting for Shell Booth, please submit application.

● Water Supply

Specification *All prices include 10% consumption tax.

< WATER SUPPLY >

Standard Inlet: 1/2" or 3/4"
Standard Outlet: 3/4" to 2"
Hydraulic Pressure: under 0.2MPa – 0.3MPa
Cost: JPY 93,500/unit for construction
*Including maintenance fee but excluding connecting charge to your equipment
JPY 803/cubic meter for use of water

< SUPPLY HOURS >

The 2nd day of move-in noon - 10:00pm
The 1st day of the show 8:00am - the end of the show
The 2nd day of the show 8:30am - the end of the show
The last day of the show 8:30am - the end of the show

*Contact the official contractor directly for early/late water supply or any other inquiries.

● Compressed Air Supply

Specification *All prices include 10% consumption tax.

< AIR PLUMBING >

Standard Air Lines: 1/2" or 3/4"
Standard Air Supply: 0.5MPa – 0.75MPa, 300 liter/min.
Exceeding in 300 liter: JPY 11,000/100 liter
Cost: JPY 93,500/unit
*Including maintenance fee but excluding connecting charge to your equipment

< SUPPLY HOURS >

The 2nd day of move-in noon - 10:00pm
The 1st day of the show 8:00am - the end of the show
The 2nd day of the show 8:30am - the end of the show
The last day of the show 8:30am - the end of the show

*Contact the official contractor directly for early/late air supply or any other inquiries.

● Handling Fire and Dangerous Materials for Exhibits and Demonstration

1. Application to Fire Department

- According to the Fire Service Act, using fire or bringing dangerous materials in the exhibition halls is prohibited. Special permission from the Fire Department is required if you wish to carry out these actions. **Please submit the application form before the stated deadline.**
- Inspections from the Fire Department will be conducted during the move-in and exhibition period. Please be aware that the equipment will have to be removed if there is any violation to fire regulations, including handling dangerous goods without application or incomplete construction. Submission after the deadline may not be approved by the Fire Department. Show Management will handle all applications to the Fire Department.
- **Prepare booth layout indicating the position of equipment, a catalogue of the equipment, a schedule of demonstration, a calculation report of consumption and quantity of heat released and a material safety data sheet (SDS/MSDS) for application.**
- If you do not receive any replies within a week after your application, please contact official contractor to avoid any oversight.

2. Guidelines for Application of the Use of Fire

(I) Definition of Naked Flame

- a. Materials which generate flames and sparks with the usage of gaseous, liquid and solid fuels, and equipment which its heating part is exposed.
- b. Equipment using electricity which its heating part is burning visibly (hotplate, hair dryer and oven is not included), and the heating part exposed may ignite when flammable materials meet the heating part (surface temperature is 400°C or above).

(II) Regarding the Use of Fire

- a. The use of fire is prohibited except when it is necessary for display for demonstration. In order to use fire at the exhibition hall, permission from the Fire Department is required. Regulations regarding energy consumption or installation have to be followed. Candles or alcohol lamps as decorations are prohibited.
- b. If you wish to use gas, please consult in advance.
- c. When it is permitted by the Fire Department as a special case, firefighting equipment must be installed in the booth. (Exhibitor is responsible for the expenses for the installation)
- d. The Fire Department will lift the restriction if there is no problem with the above guidance after the inspection. The Inspector will require for the explanation of the use of fire or gas during the inspection. The person-in-charge of the booth construction is required to station at the booth during the inspection. If the person-in-charge is not at the booth when the inspection is carried, the restriction will not be lifted.

(III) Installation and Safety Measures

- a. Flammable materials should not be placed 5m around the equipment using fire. If it is not possible to leave 5m space from the equipment using fire, separate the equipment with fireproof materials from the surroundings. In this case, the equipment should not be attached to the partition wall.
e.g. separating by pasting 2 pieces of asbestos slates with thickness of more than 15mm
- b. Equipment using fire must install measures to prevent any falls during earthquakes or outbreak of fire.
- c. Equipment using gas as fuel must have a gas-leak alarm.
- d. The person-in-charge who is responsible to operate the equipment should station at the booth at all time.
- e. Measures should be taken to ensure the user can extinguish the fire easily.
- f. Store liquified gas in cartridges.
- g. The flames generated should not be longer than 20cm.
- h. Take measures to protect the visitors from any potential dangers of fire.
- i. Refrain from any usage apart from the original purpose.
- j. Check before and after the usage.
- k. Install an ABC extinguisher (Type 10 or above) at the booth.

3. Guidelines for Application of Handling Dangerous Goods

(I) Definition of Dangerous Materials

- a. Dangerous goods include flammable liquid, oxidizing solid and liquid (e.g. gasoline and diesel fuel) according to the Fire Service Act.
- b. Designated flammable goods include flammable liquid and flammable solid under the Fire Prevention Ordinance of Chiba City.
- c. Flammable gas (e.g. propane, acetylene gas, ammonia gas, hydrogen) prescribed in the General High Pressure Security Regulations.
*You can only bring in liquefied gas which is excluded from the General High Pressure Security Regulations.
- d. Gunpowder, pyrotechnics and toy fireworks prescribed in the Explosives Control Law.

(II) Installation and Safety Measures

- a. Assign a person in charge for supervision and inspection after use.
- b. Place ABC dry chemical fire extinguisher (10lb or above) at the booth.
- c. Install device to emit the flammable steam outside the exhibition hall.
- d. Use fireproof materials to prevent the dispersion of flammable liquid.
- e. Avoid placing the dangerous goods together if they may get ignited easily.
- f. Refrain from refilling the liquid dangerous goods during the period of exhibition.
- g. Store the dangerous good in a closed container and keep it separated from the other goods.
- h. Follow the instructions of the Fire Department regarding the agreement of storing dangerous goods.

(III) Dangerous Material prescribed in Appended Table 1, Fire Service Act

Class I Petroleum (Flash point lower than 21°C)	Gasoline, Benzine, Thinner
Class II Petroleum (Flash point 21°C-69°C)	Kerosene, Gas Oil, Detergent Oil, Turpentine Oil
Class III Petroleum (Flash point 70°C-199°C)	Heavy Fuel Oil, Machine Oil, Lubricant Oil, etc.
Class IV Petroleum (Flash point 200°C or above)	Gear Oil, Cylinder Oil, Turbine Oil, Hydraulic Oil, etc.
Alcohol	Contains 60% alcohol or above
Oil extracted from animals and plants	Coconut Oil, Rapeseed Oil, Castor Oil, etc.
Inflammable solids	Lacquer Putty

*Please use water-soluble cutting oil.

(IV) Other Dangerous Goods

- a. Designated flammable material according to the Fire Prevention Ordinance (Flammable solid or liquid): paraffin, candles, raw materials of plastic.
- b. Flammable gas prescribed in the General High Pressure Security Regulations: propane, acetylene gas, hydrogen.
*You can only bring in liquefied gas which is excluded from the General High Pressure Security Regulations.
- c. Explosives prescribed in the Explosives Control Law: gunpowder, explosives, pyrotechnics.

(V) Items not considered as Dangerous Goods

The following items are not considered as dangerous goods if the amount is restricted to the minimum as needed.

- a. Exhibit : It is stored in a closed container which is for display only. Application of amount of the display is needed.
- b. Fuel or lubricant used in the tank of the vehicle for display only.
- c. Lubricant used in the motors and hydraulic machines for display.
- d. Oil for cooking and greasing the frying pan. (Deep-frying is not included.)

*The Fire Service Act and the Fire Prevention Ordinance is also applied when the total amount exceeds the prescribed amount even if it is exempted from dangerous goods.

< SUPPLEMENTARY >

★ Regarding Handling Flammable Gas

According to the Principle of Disaster from Makuhari Messe, only liquefied gas which is excluded from the General High Pressure Security Regulations is allowed to use for demonstration. Propane, acetylene gas and hydrogen (cylinder) is prohibited for any usage or demonstration.

* Only 5kg or below of liquefied gas excluded from the General High Pressure Security Regulations are allowed to be brought in.

* Liquid propane gas (LPG) stored in Cartridge up to 5kg is allowed to bring in and use.

● Carrying-in/Demonstration of Hydrogen

Carrying in hydrogen and demonstration of products using hydrogen are prohibited in the exhibition halls. However, it is permitted if it fulfills the requirements of the fire regulations.

The deadline of application is earlier than in the past years according to the instructions of the Fire Department.

Please submit the application form to the official contractor before the stated deadline. Any applications made after the deadline will not be guaranteed.

*If you do not receive any replies within a week after your application, please contact official contractor to avoid any oversight.

1. Application Procedures

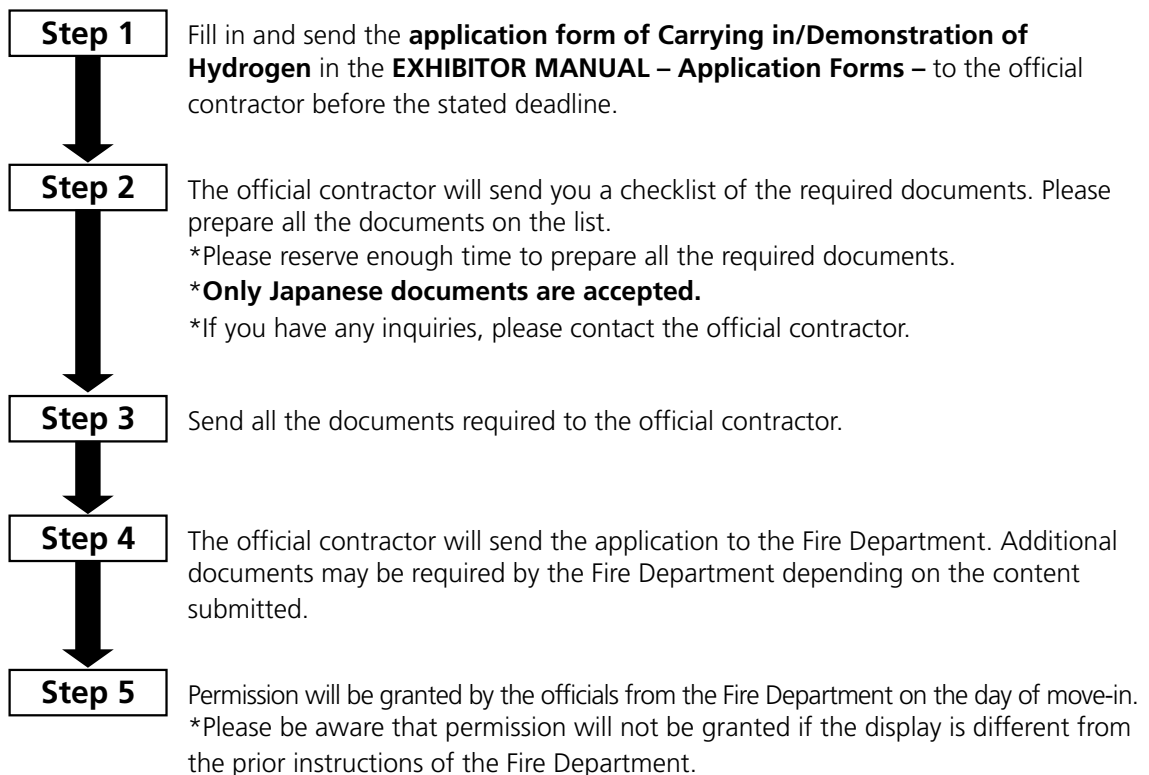

2. Caution

- (1) Application is required for carrying in hydrogen storage alloy according to the instructions of the Fire Department.
- (2) Only the minimum amount of hydrogen for daily usage is permitted for carrying in to the exhibition hall. Replenishment of hydrogen during the show period is not permitted.
- (3) Place fire extinguisher at the booth.
- (4) The person in charge for safety should be at the booth all the time, including the move-in period.
- (5) Only products approved in Japan are allowed to be used in demonstrations.
- (6) Inspections will be conducted strictly based on the Fire Prevention Ordinance.
- (7) Demonstrations may not be permitted if there is any incomplete document for application.

● Ceiling Structure

1. Exceptions for Ceiling Structure

Anything other than below are considered as ceiling structure, regardless of its size.

- Louvers and nets (both should be open more than 55%)

2. Ceiling Structure

It is prohibited to hang a ceiling unless louver boards are used to preserve water permeability.

If the exhibits do not function properly as how they are supposed to without light interception or sound insulation, please use flameproof black-out curtains or similar material for ceiling.

No matter what dimension it is, when constructing a ceiling, please inform the ceiling and shielding construction layout to the official contractor.

Please adhere to the following contents when designing the booth;

- a) Double ceiling is not allowed at all times.
- b) Materials used for decoration must be all flameproof materials. Please attach flameproof seal on these materials.
- c) You will be informed specific guidance for construction after consulting with Fire Department. (You may be asked to prepare size 10 or bigger fire extinguishers, smoke detectors, etc.)
- d) After the consultation mentioned in c), there is inspection by the Fire Department. As long as no problem is found in the inspection, they will give permission. Please be prepared to have a person in charge at the inspection to explain the structure of the construction. If there is no one to be responsible, the permission is not to be obtained.
- e) If constructing floor is higher than 30cm, consultations are needed. Please contact Show Management before the construction.

3. Forms and Consultation

*A consultation with the Fire Department is required if the ceiling structure is not an exception stated above (1. Exceptions for Ceiling Construction).

Please submit application and below documents.

- flat/elevation plan of your booth (with location of shielding curtains/fire extinguishers clearly indicated)
- detailed booth plan with description of ceiling construction (area of the ceiling, fire-proofed material of the ceiling indicated)

*A consultation with the Fire Department might take time. Forms after the deadline are not accepted in principle.

● Protection of Industrial Property Rights

1. The exhibitor is responsible for the protection of industrial property rights (patents, utility model rights, design rights and trademarks) of the products to be displayed at the exhibition. The exhibitor must take necessary actions such as patent applications, prior to participating in the exhibition.
2. The organisers of the exhibition are not responsible for protection of industrial property rights on exhibits.

● About the Use of Personal Information

1. Show Management may release exhibitors' contact information on their behalf in the event that a global media service requests it for reporting on the tradeshow or one of Show Management's designated partner companies requests it for administrative matters related to exhibiting. Those not wishing to take advantage of this service are advised to contact Show Management.
2. We are taking the utmost care with personal information. Please visit the following URL to see our company policy. <https://privacy.rxglobal.com/>

● Details of Shell Booth (3m x 3m)



- *The image above may differ from the actual booth.
- *A corner booth will have company name board(s) instead of wall panels on the side(s) facing the aisle(s).

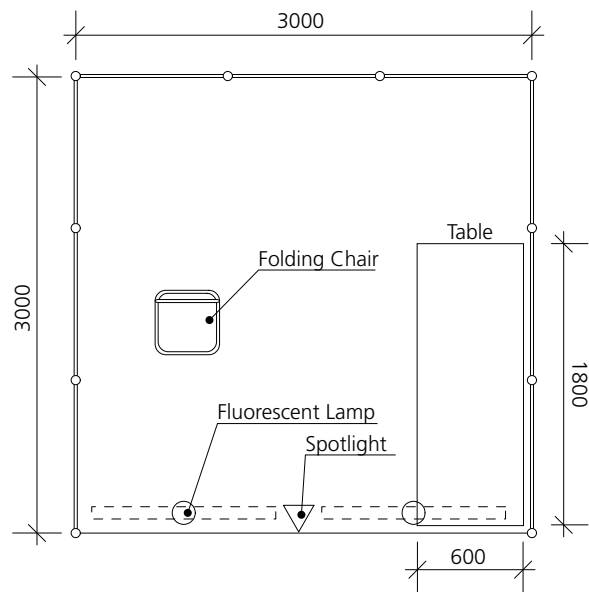

1	Back & Side Walls	H2700mm Color: Black
2	Company Name Board	Styrene Board W3000mm×H400mm Color: Black (Letters: White)
3	Needle Punch Carpet	Black
4	Furniture	Table with black cloth x1, Folding chair x1
5	Electricity	Spotlight (100W) × 1, Fluorescent Lamp (40W) × 2, Outlet (100V up to 780W) × 1, Mainline power (100V up to 1kW) is included. *Bring your own electrical transformer. *If you have any inquiries regarding electricity, contact IIDA Electrical Works Co., Ltd. directly.